

RICOH

Aficio™

1035/1045

Operating Instructions
Copy Reference

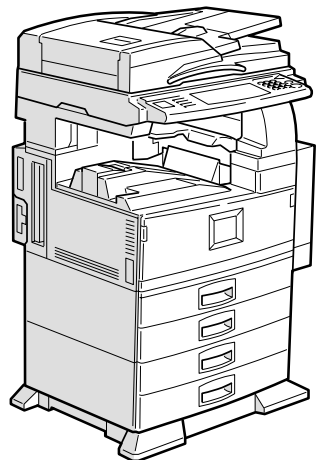

Read this manual carefully before you use this product and keep it handy for future reference.
For safety, please follow the instructions in this manual.



RICOH COMPANY, LTD.

15-5, Minami Aoyama 1-chome,
Minato-ku, Tokyo 107-8544, Japan
Phone: +81-(0)3-3479-3111

Overseas Affiliates

U.S.A.

RICOH CORPORATION
5 Dedrick Place
West Caldwell, New Jersey 07006
Phone: +1-973-882-2000

The Netherlands

RICOH EUROPE B.V.
Groenelaan 3, 1186 AA, Amstelveen
Phone: +31-(0)20-5474111

United Kingdom

RICOH UK LTD.
Ricoh House,
1 Plane Tree Crescent, Feltham,
Middlesex, TW13 7HG
Phone: +44-(0)20-8261-4000

Germany

RICOH DEUTSCHLAND GmbH
Mergenthalerallee 38-40,
65760 Eschborn
Phone: +49-(0)6196-9060

France

RICOH FRANCE S.A.
383, Avenue du Général de Gaulle
BP 307-92143 Clamart Cedex
Phone: +33-(0)-821-01-74-26

Spain

RICOH ESPAÑA S.A.
Avda. Litoral Mar, 12-14,
08005 Barcelona
Phone: +34-(0)93-295-7600

Italy

RICOH ITALIA SpA
Via della Metallurgia 12,
37139 Verona
Phone: +39-045-8181500

Hong Kong

RICOH HONG KONG LTD.
21/F., Tai Yau Building,
181, Johnston Road,
Wan Chai, Hong Kong
Phone: +852-2862-2888

Singapore

RICOH ASIA PACIFIC PTE.LTD.
260 Orchard Road,
#15-01/02 The Heeren,
Singapore 238855
Phone: +65-830-5888

Introduction

This manual contains detailed instructions on the operation and maintenance of this machine. To get maximum versatility from this machine all operators should carefully read and follow the instructions in this manual. Please keep this manual in a handy place near the machine.

Please read the Safety Information before using this machine. It contains important information related to USER SAFETY and PREVENTING EQUIPMENT PROBLEMS.

Notes

Some illustrations may be slightly different from your machine.

Certain options may not be available in some countries. For details, please contact your local dealer.

Operator Safety

This machine is considered a class 1 laser device, safe for office/EDP use. The machine contains two GaAlAs laser diodes, 5-milliwatt, 760-800 nanometer wavelength for each emitter. Direct (or indirect reflected) eye contact with the laser beam might cause serious eye damage. Safety precautions and interlock mechanisms have been designed to prevent any possible laser beam exposure to the operator.

The following label is attached on the right side of the machine.



Laser Safety:

The optical housing unit can only be repaired in a factory or at a location with the requisite equipment. The laser subsystem is replaceable in the field by a qualified Customer Engineer. The laser chassis is not repairable in the field. Customer engineers are therefore directed to return all chassis and laser subsystems to the factory or service depot when replacement of the optical subsystem is required.

Warning:

Use of controls or adjustment or performance of procedures other than those specified in this manual might result in hazardous radiation exposure.

Notes:

The model names of the machines do not appear in the following pages. Check the type of your machine before reading this manual. (For details, ⇒ P.1 "Machine Types".)

- Type1: Aficio 1035
- Type2: Aficio 1045

Certain types might not be available in some countries. For details, please contact your local dealer.

Two kinds of size notation are employed in this manual. With this machine refer to the metric version.

For good copy quality, Ricoh recommends that you use genuine Ricoh toner.

Ricoh shall not be responsible for any damage or expense that might result from the use of parts other than genuine Ricoh parts in your Ricoh office product.

Power Source

220 - 240V, 50/60Hz, 8A or more

Please be sure to connect the power cord to a power source as above. For details about power source, ⇒ P.231 "Power Connection".

In accordance with IEC 60417, this machine uses the following symbols for the main power switch:

I means **POWER ON**.

⏻ means **STAND BY**.

Safety Information

When using your equipment, the following safety precautions should always be followed.

Safety During Operation

In this manual, the following important symbols are used:

⚠ WARNING:
Indicates a potentially hazardous situation which, if instructions are not followed, could result in death or serious injury.

⚠ CAUTION:
Indicates a potentially hazardous situation which, if instructions are not followed, may result in minor or moderate injury or damage to property.

⚠ WARNING:

- **Connect the power cord directly into a wall outlet and never use an extension cord.**
- **Disconnect the power plug (by pulling the plug, not the cable) if the power cable or plug becomes frayed or otherwise damaged.**
- **To avoid hazardous electric shock or laser radiation exposure, do not remove any covers or screws other than those specified in this manual.**
- **Turn off the power and disconnect the power plug (by pulling the plug, not the cable) if any of the following conditions exists:**
 - **You spill something into the equipment.**
 - **You suspect that your equipment needs service or repair.**
 - **Your equipment's cover has been damaged.**
- **Do not incinerate spilled toner or used toner. Toner dust might ignite when exposed to an open flame.**
- **Disposal can take place at our authorized dealer or at appropriate collection sites.**
- **Dispose of the used toner bottle in accordance with the local regulation.**

⚠ CAUTION:

- *Protect the equipment from dampness or wet weather, such as rain, snow, and so on.*
- *Unplug the power cord from the wall outlet before you move the equipment. While moving the equipment, you should take care that the power cord will not be damaged under the equipment.*
- *When you disconnect the power plug from the wall outlet, always pull the plug (not the cable).*
- *Do not allow paper clips, staples, or other small metallic objects to fall inside the equipment.*
- *Keep toner (used or unused) and toner bottle out of the reach of children.*
- *For environmental reasons, do not dispose of the equipment or expended supply waste at household waste collection points. Disposal can take place at an authorized dealer or at appropriate collection sites.*
- *The inside of the machine could be very hot. Do not touch the parts with a label indicating the “hot surface”. Otherwise it could cause a personal burn.*
- *Our products are engineered to meet high standards of quality and functionality, and we recommend that you only use the expendable supplies available at an authorized dealer.*

How to Read this Manual

Symbols

In this manual, the following symbols are used:

WARNING:

This symbol indicates a potentially hazardous situation that might result in death or serious injury when you misuse the machine without following the instructions under this symbol. Be sure to read the instructions, all of which are included in the Safety Information section.

CAUTION:

This symbol indicates a potentially hazardous situation that might result in minor or moderate injury or property damage that does not involve personal injury when you misuse the machine without following the instructions under this symbol. Be sure to read the instructions, all of which are included in the Safety Information section.

- WARNINGS and CAUTIONS are notes for your safety.

Important

If this instruction is not followed, paper might be misfeed, originals might be damaged, or data might be lost. Be sure to read this.

Preparation

This symbol indicates the prior knowledge or preparations required before operating.

Note

This symbol indicates precautions for operation or actions to take after misoperation.

Limitation

This symbol indicates numerical limits, functions that cannot be used together, or conditions in which a particular function cannot be used.

Reference

This symbol indicates a reference.

[]

Keys that appear on the machine's display panel.

[]

Keys built into the machine's control panel.

TABLE OF CONTENTS

Machine Types	1
What You Can Do with This Machine (Copy Mode)	2
Guide To Components	5
Output Tray Guide.....	7
Options	8
Control Panel	9
Display Panel	11
Displays and Key Operations.....	11
Function List Based on Options	13

1. Basics

Turning On the Power	15
Turning On the Main Power.....	15
Turning On the Power.....	16
Turning Off the Power.....	16
Changing Modes	17
Originals	18
Sizes and Weights of Recommended Originals.....	18
Sizes Detectable by the Auto Paper Select.....	19
Missing Image Area.....	20
Copy Paper	21
Recommended Paper Sizes and Types.....	21
Direction-fixed paper or 2-sided paper.....	24
Non-recommended Paper.....	25
Paper Storage.....	25
Toner	26
Handling Toner.....	26
Toner Storage.....	26
Used Toner.....	26

2. Copying



Basic Procedure	27
Setting Originals	29
Setting Originals on the Exposure Glass	29
Setting Originals in the Document Feeder	30
Original Orientation	30
Setting Special Originals	31
Mixed Size mode.....	32
Setting Custom Size Originals	33
Basic Functions	35
Adjusting Copy Image Density	35
Selecting Original Type Setting.....	36
Selecting Copy Paper	38
Auto Reduce/Enlarge	41
Sort/Stack/Staple	42
Sort.....	43
Stack	45
Staple	47
To Stop Scanning Temporarily.....	52
When Memory Reaches 0%	52
To Remove the Paper from the Staple Unit	53
Punch	54
Copying from the Bypass Tray	58
When Copying onto OHP Transparencies or Thick Paper.....	60
Programs	62
Storing a Program	62
Deleting a Program	63
Recalling a Program.....	64
Job Preset	65
Other Functions	66
Energy Saver Mode	66
Interrupt Copy	66
Original Beeper	67
Sample Copy.....	67
Changing the Number of Sets.....	67
Preset Reduce/Enlarge	69
Create Margin mode	70
Zoom	71
Size Magnification	73
Directional Magnification (%)	75
Directional Size Magnification (mm)	77
Duplex/Combine/Series	79
Original Direction and Completed Copies	80
Originals and Copy Direction	80
Specifying Orientation of Bound Originals	80



Duplex.....	82
1 Sided → 2 Sided	82
2 Sided → 2 Sided	83
Combine	85
1 Sided 2 Pages → Combine 1 Side.....	86
1 Sided 4 Pages → Combine 1 Side.....	87
1 Sided 8 Pages → Combine 1 Side.....	88
1 Sided 4 Pages → Combine 2 Side.....	89
1 Sided 8 Pages → Combine 2 Side.....	90
1 Sided 16 Pages → Combine 2 Side.....	91
2 Sided 2 Pages → Combine 1 Side.....	92
2 Sided 4 Pages → Combine 1 Side.....	93
2 Sided 8 Pages → Combine 1 Side.....	94
2 Sided 4 Pages → Combine 2 Side.....	95
2 Sided 8 Pages → Combine 2 Side.....	96
2 Sided 16 Pages → Combine 2 Side.....	97
Series/Book.....	98
Series Copies.....	98
Copying Book Originals.....	102
Edit Image	109
Image Repeat.....	109
Double Copies.....	110
Centering.....	111
Positive/Negative	112
Erase.....	113
Border Erase	114
Center Erase	115
Center/Border Erase	116
Margin Adjustment	118
Stamp.....	120
Background Numbering	120
Preset Stamp	121
User Stamp	123
Program/Delete User Stamp	125
Date Stamp	127
Page Numbering	130
Cover/Slip Sheet.....	135
Front Cover	135
Front/Back Covers	136
Designate.....	138
Chapter	139
Slip Sheets	141
Combination Chart	143

3. Document Server

Overview	145
Process	146
Features and Benefits	147
On Demand Printing.....	147
File Merge Printing	149
Facsimile Resend.....	151
Operation from a Computer	152
Scanning Originals	153
Scanning in Document Server mode	153
Scanning in Copy mode	156
Printing Saved Documents	157
Sample Printing.....	159
Print First Page	159
Searching Saved Documents	160
To Search by File Name	160
To Search by User Name.....	160
To Check the Details of Stored Documents	161
Deleting Saved Documents	162

4. Troubleshooting

If Your Machine Does Not Operate as You Want	165
General	165
Document Server	167
Display	168
If You Cannot Make Clear Copies	169
If You Cannot Make Copies As You Want	170
General	170
Adjust Image	171
Stamp	171
Combine.....	172
Duplex.....	173
When Memory Is Full	174
 Loading Paper	175
Loading Paper in Tray 1 or 2.....	175
Loading Paper in Tray 3 or 4.....	176
Loading Paper in the Large Capacity Tray.....	177
 Adding Toner	178
 Clearing Misfeeds	181
Changing the Paper Size	188
Changing the Paper Size in Tray 1 or 2	188
Changing the Paper Size in Tray 3 or 4	190

 Adding Staples	192
1000-Sheet Finisher.....	192
2 Tray Finisher	194
 Removing Jammed Staples	196
1000-Sheet Finisher.....	196
2 Tray Finisher	198
 Removing Punch Waste	200

5. User Tools (Copy/Document Server Features)

Accessing the User Tools (Copy/Document Server Features)	201
Exiting From the User Tools.....	202
User Tools Menu (Copier/Document Server Features)	204
General Features ¹/₄	206
General Features ²/₄	209
General Features ³/₄	211
General Features ⁴/₄	212
Reproduction Ratio ¹/₂	213
Reproduction Ratio ²/₂	214
Edit ¹/₂	216
Edit ²/₂	218
Stamp	221
Background Numbering	221
Preset Stamp ¹ / ₄ - ⁴ / ₄	221
User Stamp ¹ / ₂ - ² / ₂	222
Date Stamp	223
Page Numbering ¹ / ₂ - ² / ₂	224
Input/Output	226

6. REMARKS





Do's And Don'ts	229
Where to Put Your Machine	230
Machine Environment	230
Moving.....	230
Power Connection.....	231
Access to the Machine	231
Maintaining Your Machine	232
Cleaning the Exposure Glass.....	232
Cleaning the Platen Cover	232
Cleaning the Document Feeder	232

7. Specification

Mainframe	233
Document Feeder (Option)	237
1000-Sheet Finisher (Option)	238
2 Tray Finisher (Option)	239
Punch Kit (Option)	241
Internal tray 2 (1 bin tray) (Option)	242
External Tray (Option)	243
Large Capacity Tray (LCT) (Option)	244
Paper tray unit (Option)	245
INDEX	246

Machine Types

This machine comes in two models which vary by copy speed. To make sure which model you have, see the inside front cover.

	Type 1	Type 2
Copy speed	35 copies/minute (A4  , 8 ¹ / ₂ " × 11" )	45 copies/minute (A4  , 8 ¹ / ₂ " × 11" )

What You Can Do With This Machine (Copy Mode)

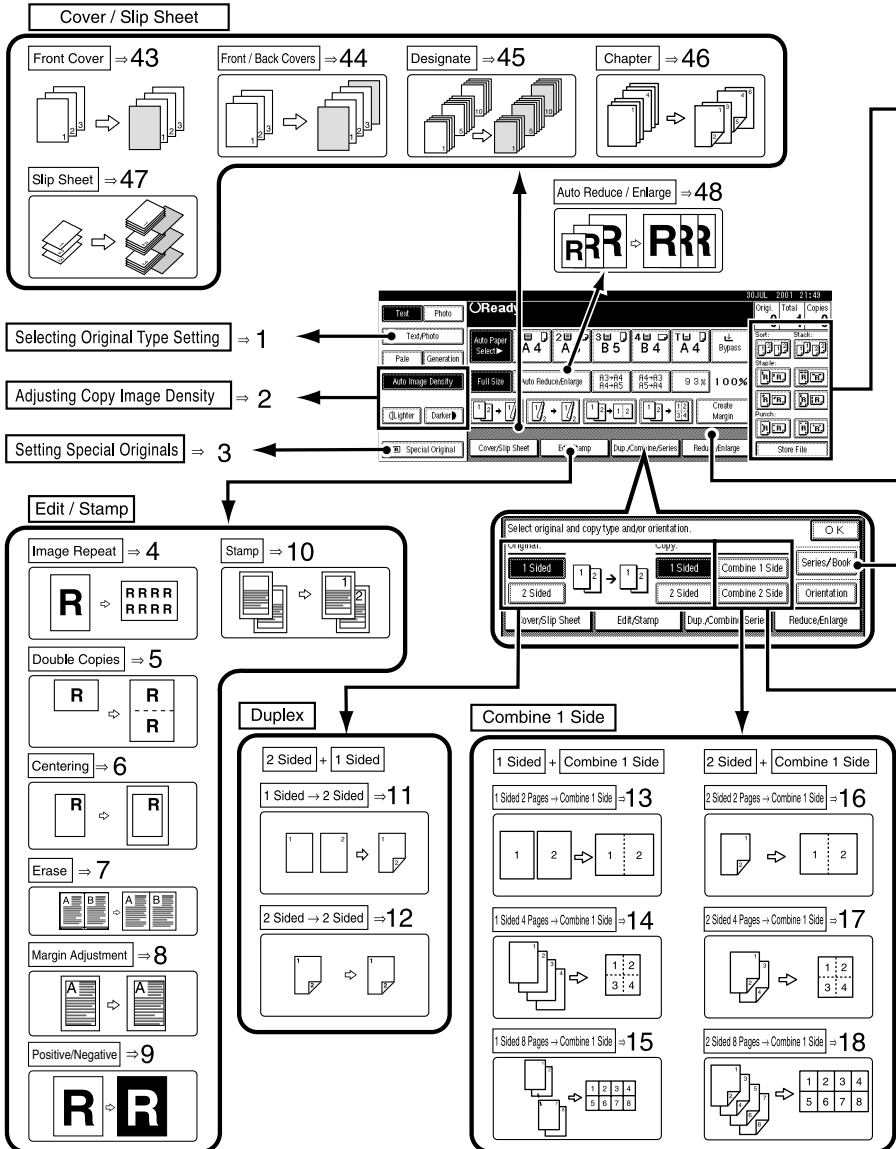

*1 Optional 2 Tray finisher is required.

*2 Optional Bridge unit and optional finisher are required.

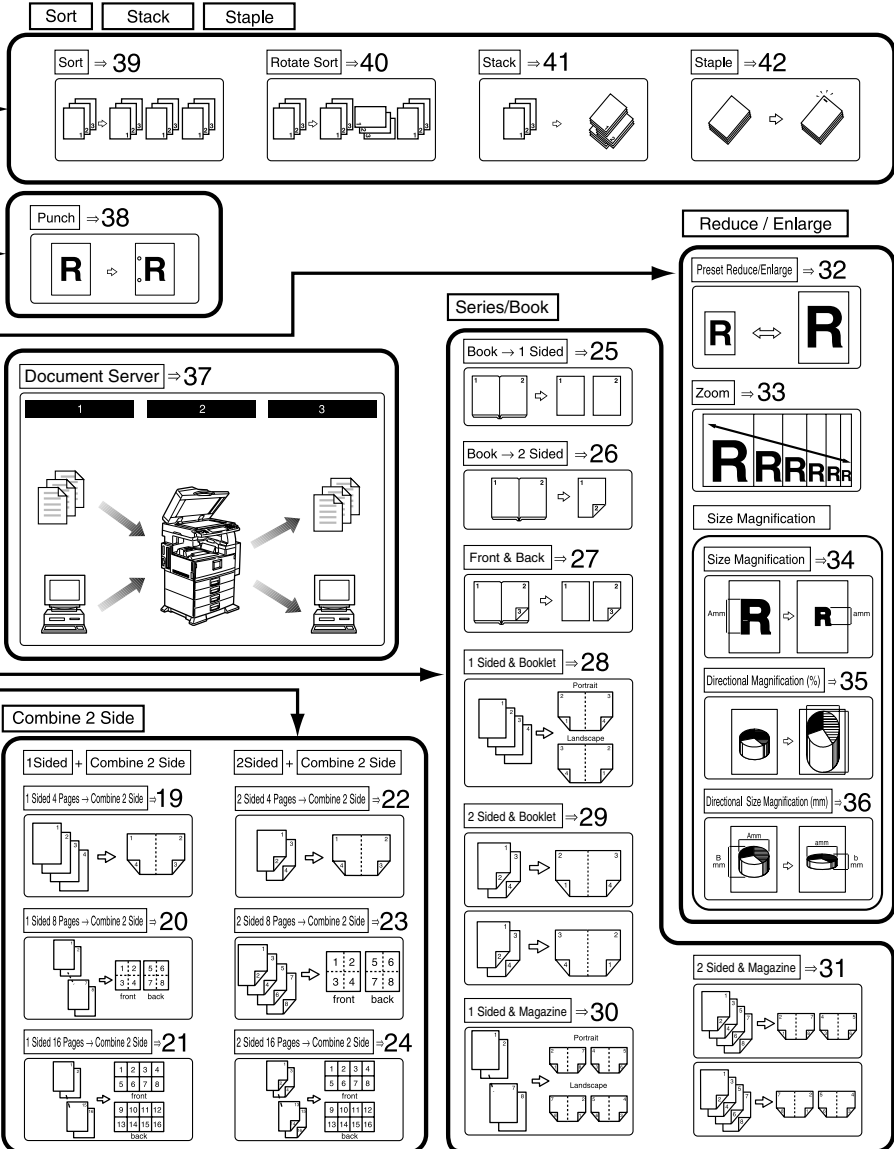

1. "Selecting Original Type Setting" ⇒ P.36
2. "Adjusting Copy Image Density" ⇒ P.35
3. "Setting Special Originals" ⇒ P.31
4. "Image Repeat" ⇒ P.109
5. "Double Copies" ⇒ P.110
6. "Centering" ⇒ P.111
7. "Erase" ⇒ P.113
8. "Margin Adjustment" ⇒ P.118
9. "Positive/Negative" ⇒ P.112
10. "Stamp" ⇒ P.120
11. "1 Sided → 2 Sided" ⇒ P.82
12. "2 Sided → 2 Sided" ⇒ P.83
13. "1 Sided 2 Pages → Combine 1 Side" ⇒ P.86
14. "1 Sided 4 Pages → Combine 1 Side" ⇒ P.87
15. "1 Sided 8 Pages → Combine 1 Side" ⇒ P.88
16. "2 Sided 2 Pages → Combine 1 Side" ⇒ P.92
17. "2 Sided 4 Pages → Combine 1 Side" ⇒ P.93
18. "2 Sided 8 Pages → Combine 1 Side" ⇒ P.94
19. "1 Sided 4 Pages → Combine 2 Side" ⇒ P.89
20. "1 Sided 8 Pages → Combine 2 Side" ⇒ P.90
21. "1 Sided 16 Pages → Combine 2 Side" ⇒ P.91
22. "2 Sided 4 Pages → Combine 2 Side" ⇒ P.95
23. "2 Sided 8 Pages → Combine 2 Side" ⇒ P.96
24. "2 Sided 16 Pages → Combine 2 Side" ⇒ P.97
25. "Book → 1 Sided" ⇒ P.98
26. "Book → 2 Sided" ⇒ P.99
27. "Front & Back → 2 Sided" ⇒ P.100
28. "1 Sided → Booklet" ⇒ P.102
29. "2 Sided → Booklet" ⇒ P.104
30. "1 Sided → Magazine" ⇒ P.105
31. "2 Sided → Magazine" ⇒ P.107
32. "Preset Reduce/Enlarge" ⇒ P.69
33. "Zoom" ⇒ P.71
34. "Size Magnification" ⇒ P.73
35. "Directional Magnification (%)" ⇒ P.75
36. "Directional Size Magnification (mm)" ⇒ P.77
37. "Document Server" ⇒ P.145
38. "Punch" ⇒ P.54
39. "Sort" ⇒ P.43
40. "Rotate Sort" ⇒ P.43
41. "Stack" ⇒ P.45
42. "Staple" ⇒ P.47
43. "Front Cover" ⇒ P.135
44. "Front/Back Covers" ⇒ P.136
45. "Designate" ⇒ P.138
46. "Chapter" ⇒ P.139
47. "Slip Sheets" ⇒ P.141
48. "Auto Reduce/Enlarge" ⇒ P.41

Guide To Components

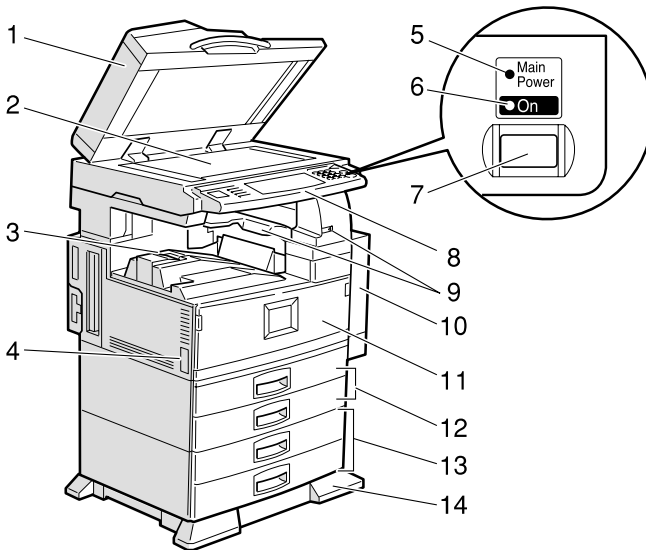

ZCAH030A

1. Document Feeder (ADF)

The document feeder automatically feeds a stack of originals one by one.

2. Exposure glass

Place originals here face down for copying. ⇒ P.18 "Originals"

3. Internal tray

Copied paper is delivered here face down.

4. Main power switch

If the machine does not operate after turning on the operation switch, check if the main power switch is turned on. If it is off, turn it on.

5. Main power indicator

This indicator light up when the main power switch is turned on, and goes off when the switch is turned off.

6. On indicator

This indicator lights up when the operation switch is turned on, and goes off when the switch is turned off.

7. Operation switch

Press this switch to turn the power on (the **On** indicator light up). To turn the power off, press this switch again (the **On** indicator goes off).

8. Control panel

⇒ P.9 "Control Panel"

9. Remove Paper Indicator

The indicator is lit when paper is output to the internal tray 2 (1 bin tray). When paper is removed from the internal tray 2, the indicator goes off.

Note

Internal tray 2 (1 bin tray) is optional.

10. Duplex unit (Unit for two-sided copies)

Makes two-sided copies.

11. Front cover

Open to access the inside of the machine.

12. Paper tray

Set paper here.

13. Paper tray unit (Option)

14. Holding stand

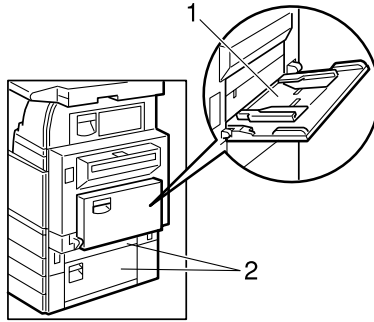

ZDSH020J

1. Bypass tray

Use when copying onto OHP transparencies, adhesive labels, translucent paper, postcards, and custom size paper.

2. Right side cover

Open this when a paper jam occurs.

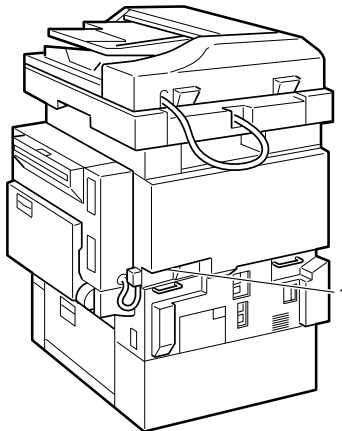

ZCAH100E

1. Ventilation hole

Prevents overheating. Do not obstruct the ventilation hole by placing an object near it or leaning an object against it. If the machine overheats, a fault might occur.

Output Tray Guide

When copying onto OHP transparencies and translucent paper, raise the guide. This prevents copies from being curled when delivered.

❖ **To copy onto normal paper and thick paper**

Slide the guide in the direction of the arrow.

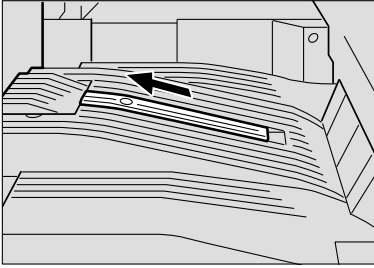

ZDSH070J

❖ **To copy onto OHP transparencies and translucent paper**

Insert your forefinger into the indent on the guide and slide the guide to the right.

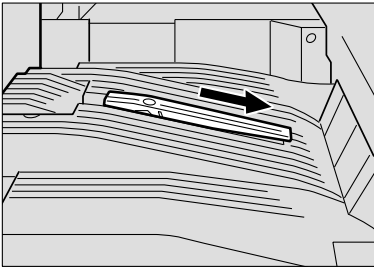

ZDSH071J

❖ **To copy onto A3, 11" × 17" paper**

Raise the end fence.

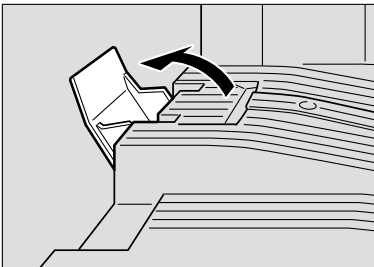

ZDSH090J

Options

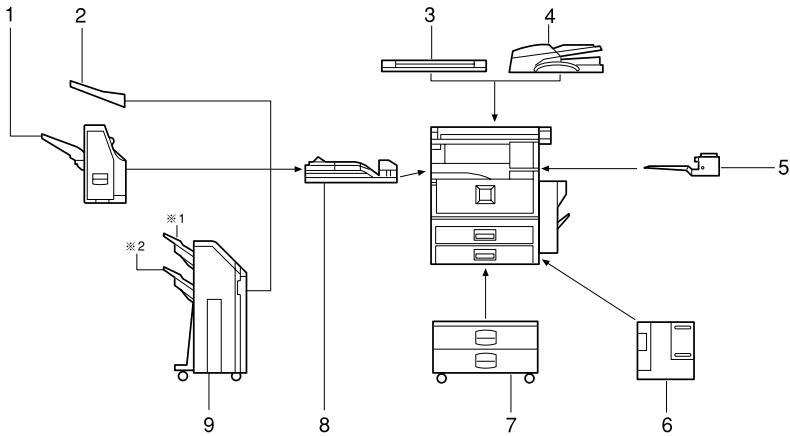

ZCAX959E

1. 1000-Sheet Finisher

Sorts, stacks, and staples copies.

2. External tray

If you selected this as the output tray, copied paper is delivered here face down.

3. Platen cover

Lower this cover over originals for copying.

4. Document feeder (ADF) ⇒ P.30

Insert a stack of originals here. They will be fed automatically.

5. Internal tray 2 (1 bin tray)

If you selected this as the output tray, copied paper is delivered here face down.

6. Large Capacity Tray (LCT)

Holds 1,500 sheets of paper.

7. Paper tray unit

Consists of two paper trays.

8. Bridge unit

Relays copies to the external tray or finisher.

9. 2 Tray Finisher

Sorts, stacks, and staples copies. You can also punch copies. (The Punch function is optional.)

- 1: Finisher shift tray 1
- 2: Finisher shift tray 2

Control Panel

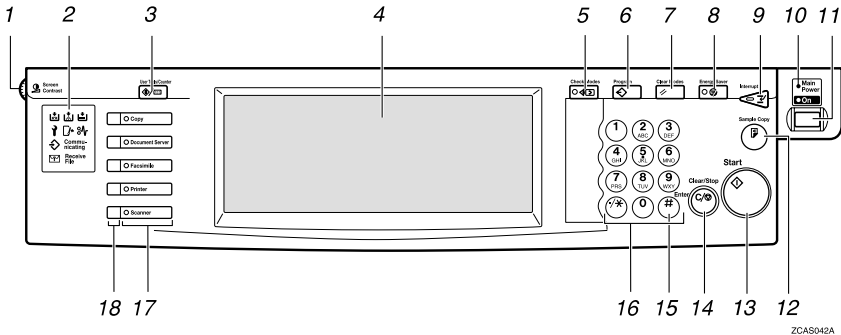

ZCAS042A

1. Screen Contrast knob

Adjusts the brightness of the display panel.

2. Indicators

These indicators show errors or the status of the machine. ⇒ P.165 "Troubleshooting".

3. [User Tools/Counter] key

- User Tools
Press to change the default settings and conditions to meet your requirements.
- Counter
Press to check or print the total number of copies made.

4. Display panel

Shows operation status, error messages, and function menus. ⇒ P.11 "Display Panel".

5. [Check Modes] key

Press to check the entered copy job settings.

6. [Program] key

Press to select the program mode. ⇒ P.62 "Programs".

7. [Clear Modes] key

Press to clear the previously entered copy job settings.

8. [Energy Saver] key

Press to switch to and from Energy Saver mode. ⇒ P.66 "Energy Saver Mode".

9. [Interrupt] key

Press to make interrupt a long copy job to make copies. ⇒ P.66 "Interrupt Copy".

10. Main power indicator

This indicator goes on when the main power switch is turned on, and goes off when the switch is turned off.

11. Operation switch

Press this switch to turn the power on (the **On** indicator goes on). To turn the power off, press this switch again (the **On** indicator goes off).

12. [Sample Copy] key

Use this key to make a single sample copy before starting a long copy run. By checking the sample copy and making any necessary changes to the image quality settings before you make multiple copies, you can save time and paper. ⇒ P.67 "Sample Copy".

13. [Start] key

Press to start copying. Press to start scanning and printing in Document Server mode.

14. [Clear/Stop] key

- Clear
Press to delete a number entered.
- Stop
Press to stop a copy job in progress.

15. [#] key

Press to enter a value.

16. Number keys

Use to enter the desired number of copies and data for selected modes.

17. Function keys

Press the appropriate key to choose any of the following functions:

- Copy
- Document Server
- Facsimile
- Printer
- Scanner

18. Function Status indicator

These show the status of the above functions:

- Yellow: the function is selected.
- Green: the function is active.
- Red: the function has been interrupted.

Display Panel

The display panel shows the status of the machine, error messages and function menus.

Important

- Do not apply a strong shock or force of about 30 N (about 3 kgf) or more to the display panel. If you do, the display might be damaged.

Note

- The function items displayed serve as selector keys. You can select or specify an item by lightly pressing it.
- When you select or specify an item on the display panel, it is highlighted like **Full Size**.
- Keys appearing as **OK** cannot be used.

Displays and Key Operations

Note

- The following illustrations are examples for the machine with the optional 2 Tray finisher and large capacity tray (LCT) installed.

◆ Initial copy display

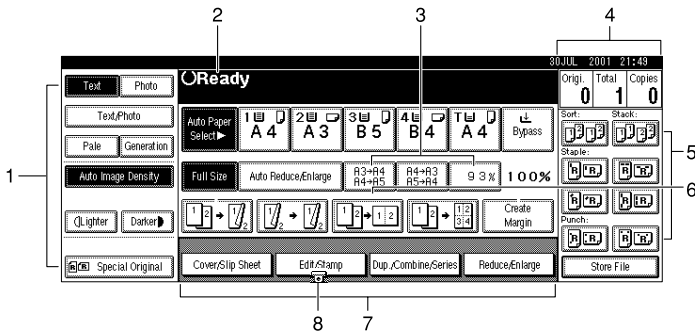

ZCAS130E

1. Original mode, Image Density and Special Original mode.

2. Operational status or messages.

3. You can register up to three frequently used reduce/enlarge ratios other than the fixed reduce/enlarge ratios. ⇒ "Shortcut R/E" in P.213 "Reproduction Ratio $1/2$ ".

4. The number of originals scanned into memory, number of copies set, and number of copies made.

5. Sort, Stack, Staple or Punch mode.

6. Displays the contents of the Shortcut keys. You can register frequently used functions in these keys. ⇒ "Copy Function Key F1-F5" in P.211 "General Features $3/4$ ".

7. Shows the available functions. Press a function name to display its menu. For example, press the [Reduce/Enlarge] key to bring up the Reduce/Enlarge menu.

8. A clip mark appears for a currently selected function.

◆ Function menu

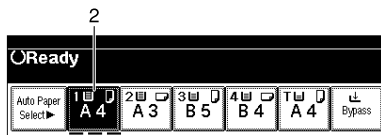
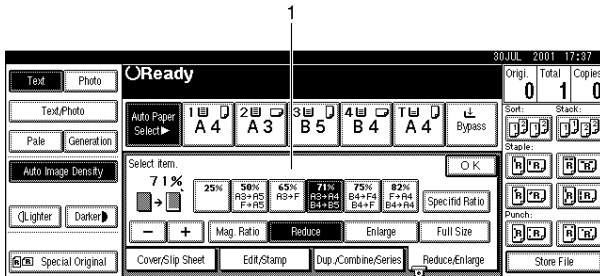

ZCAS140E

1. Items you can select.

2. The key highlighted with the lower line underlined indicates the tray feeding the paper.

◆ Document Server initial display

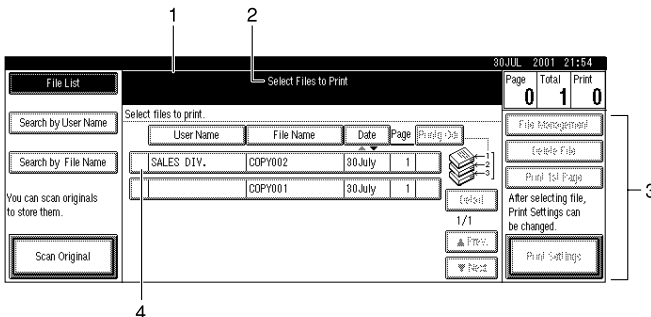

ZCAS150E

1. Operational status and messages.

3. Operational keys.

2. Display titles.

4. Documents sent by fax.

Function List Based on Options



The functions that are available to you depend on your machine configuration and which options you have. See the table below.

○...Available

×...Not available

		Type 1	Type 2	Place originals	
				on the expo- sure glass	in the docu- ment feeder
Mixed Sizes Mode		○ *5	○ *5	○	○
Custom Size Originals		○	○	○	○
Original Orientation (Standard Orientation)		○	○	○	○
Auto Image Density		○	○	○	○
Manual Image Density		○	○	○	○
Auto Paper Select		○	○	○	○
Manual Paper Select		○	○	○	○
Copying from the Bypass Tray		○	○	○	○
Sample Copy/Job Preset		○	○	○	○
Auto Reduce/Enlarge		○	○	○	○
Reduce/Enlarge		○	○	○	○
Create Margin Mode		○	○	○	○
Book		○	○	○	○
Duplex		○	○	○	○
Combine	1 Sided 2 pages, 4 pages, 8 pages, → 1 Side	○	○	○	○
	1 Sided 4 pages, 8 pages, 16 pages, → 2 Side	○	○	○	○
	2 Sided 2 pages, 4 pages, 8 pages, → 1 Side	○	○	○	○
	2 Sided 4 pages, 8 pages, 16 pages, → 2 Side	○	○	○	○
Series	Book → 1 Sided	○	○	○	×
	Book → 2 Sided	○	○	○	×
	Front & Back → 2 Sided	○	○	○	×

	Type 1	Type 2	Place originals	
			on the expo- sure glass	in the docu- ment feeder
Copying Book Originals	○	○	○	○
Image Repeat	○	○	○	○
Double Copies	○	○	○	○
Centering	○	○	○	○
Positive/Negative	○	○	○	○
Border Erase/Center Erase	○	○	○	○
Margin Adjustment	○	○	○	○
Background Numbering	*6	*6	○	○
Preset Stamp	*6	*6	○	○
User Stamp	*6	*6	○	○
Date Stamp/Page Numbering	○	○	○	○
Cover/Front/Back Cover/Slip Sheet	○	○	○	○
Sort	○	○	○	○
Shift Sort	*3	*3	○	○
Rotate Sort	*1 *2	*1 *2	○	○
Shift Stack	*3	*3	○	○
Staple	*3	*3	○	○
Punch	*4	*4	○	○
Store File	○	○	○	○

*1 Set the paper of the same size   in the paper trays.

*2 You can use this function when “Rotate Sort” is selected in “Select Stack Function”.

*3 1000-sheet Finisher or 2 Tray Finisher and Bridge unit required.

*4 2 Tray Finisher and Bridge unit required.

*5 Document feeder required.

*6 32 MB Memory required. (If the machine is equipped with the Printer unit, 32 MB memory is not required.)

Turning On the Power

To turn the machine on, press the operation switch.

Note

- ❑ This machine automatically enters Energy Saver mode or turns itself off if you do not use the machine for a while. P.28 "Auto Off" and "Timer Setting" in the System Settings manual.

Power switches

This machine has two power switches. ⇒ P.5 "Guide To Components"

◆ Operation switch (right side of the control panel)

Press this switch to activate the machine. When the machine has warmed up, you can make copies.

Turning On the Main Power

- 1** Make sure that the power cord is firmly plugged into the wall outlet.
- 2** Open the switch cover and turn on the main power switch (make sure that the Main Power indicator goes on).

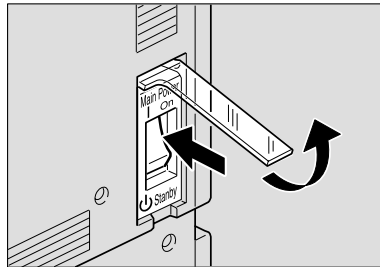

ZDSH040J

Important

- ❑ Do not switch off the main power immediately after it has been switched on. Failure to observe this may result in damage to the hard disk or memory, leading to malfunctions.

Turning On the Power

- 1 Press the operation switch to make the On indicator goes on.

The display panel will come on.

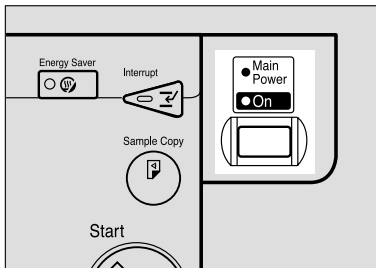

ZCAS050N

Note

- If the power is not turned on when the operation switch is pressed, check if the main power switch is on. If off, turn it on.
- During the warm-up period (less than 10 seconds for Type 1, less than 15 seconds for Type 2), you can use the Auto Start function.

Turning Off the Power

- 1 Make sure that the platen cover or the document feeder is in the right position.
- 2 Press the operation switch to make the On indicator goes off.

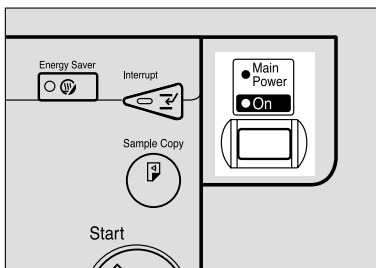

ZCAS050N

Note

- Even if you press the operation switch, the indicator do not goes off and blink in the following cases:
 - When the platen cover or the document feeder is open.
 - When communication is in progress with external equipment.
 - When the hard disk is operating.

Turning Off the Main Power

- 1 Make sure that the On indicator goes off.
- 2 Turn off the main power switch to make sure the indicator goes off.

Important

- Do not turn off the main power switch when the indicator goes on or blink Hard Disk or Memory might be broken.
- Pull out the power plug after you turn off the main power switch. Hard Disk or Memory might be broken.
- If the main power switch is turned off, or the power plug is disconnected, any documents stored in fax memory will be lost after approximately one hour elapses.

Changing Modes

You can use this machine not only as a copier, but also as a fax, printer, document server and scanner as well. Press the **[Copy]**, **[Facsimile]**, **[Printer]**, **[Scanner]** or **[Document Server]** key to use that function.

The diagram illustrates the process of switching between different machine modes. A central control panel shows five main mode selection buttons: Copy, Document Server, Facsimile, Printer, and Scanner. Arrows from these buttons point to detailed screenshots of each mode's interface.

- Copy Mode:** Shows a 'Ready' screen with various settings like Paper (A3, A4, B5, B4), Auto Image Density, and Full Size (7.38, 1.558, 0.34, 100%).
- Document Server Mode:** Shows a 'File List' screen with search options by User Name or File Name, and a 'Scan Original' button.
- Facsimile Mode:** Shows a 'Ready' screen for fax transmission with fields for To, From, and Original Mode, and a 'Send' button.
- Printer Mode:** Shows a 'Ready' screen with 'Paper Tray Status' and 'Sample Print/Locked Print' options.
- Scanner Mode:** Shows a 'Ready' screen with 'Scan Settings', 'Recall Program', and 'Scan File Message' options.

GDSH070N

Limitation





□ You cannot switch modes in the following cases:

- During interrupt copying
- When scanning in a fax message for transmission
- During immediate transmission
- During on hook dialing for fax transmission
- While scanning an original
- When accessing the user tools





Originals

Sizes and Weights of Recommended Originals

◆ Metric version

Where Original Is Set	Original Size	Original Weight
Exposure glass	Up to A3	--
Document feeder	1-sided originals: A3  – B6 	40 – 128g/m ²
	2-sided originals: A3  – A5 	52 – 105g/m ²

◆ Inch version

Where Original Is Set	Original Size	Original Weight
Exposure glass	Up to 11" × 17"	--
Document feeder	1-sided originals: 11" × 17"  – 5 ¹ / ₂ " × 8 ¹ / ₂ " 	11 – 34 lb.
	2-sided originals: 11" × 17"  – 5 ¹ / ₂ " × 8 ¹ / ₂ " 	14 – 28 lb.

Note

- The number of originals that can be set in the document feeder is about 80.
- Original weight in Mixed Size mode is 52-81g/m², 13.8-21.5 lb.

Non-recommended originals for the document feeder

Setting the following types of originals in the document feeder can cause paper misfeeds or damage to the originals. Set these originals on the exposure glass instead.

- Originals other than those specified in ⇒ P.18 “*Sizes and Weights of Recommended Originals*”
- Stapled or clipped originals
- Perforated or torn originals
- Curled, folded, or creased originals
- Pasted originals
- Originals with any kind of coating, such as thermal fax paper, art paper, aluminum foil, carbon paper, or conductive paper
- Originals with perforated lines

- Originals with indexes, tags, or other projecting parts
- Sticky originals such as translucent paper
- Thin originals that have low stiffness
- Thick originals such as postcards
- Originals of inappropriate weight
- Bound originals such as books
- Transparent originals such as OHP transparencies or translucent paper
- Originals that have correction fluid or ink on them that has not completely dried

Sizes Detectable by the Auto Paper Select

◆ Metric version

Size Place of original	A3 ☐	B4 ☐	A4 ☐	B5 ☐	A5 ☐	11" × 17" ☐	8 ¹ / ₂ " × 14" ☐	8 ¹ / ₂ " × 11" ☐☐	5 ¹ / ₂ " × 8 ¹ / ₂ " ☐☐	8 ¹ / ₂ " × 13" ☐
Exposure glass	○	○	○	○	×	×	×	×	×	○
Document feeder	○	○	○	○	○	○	×	×	×	○

◆ Inch version

Size Place of original	A3 ☐	B4 ☐	A4 ☐	B5 ☐☐	A5 ☐☐	11" × 17" ☐	8 ¹ / ₂ " × 14" ☐	8 ¹ / ₂ " × 11" ☐☐	5 ¹ / ₂ " × 8 ¹ / ₂ " ☐☐	8 ¹ / ₂ " × 13" ☐	7 ¹ / ₄ " × 10 ¹ / ₂ " ☐
Exposure glass	×	×	×	×	×	○	○	○	×	×	×
Document feeder	×	×	○	×	×	○	○	○	○	○	○

Sizes difficult to detect

It is difficult for the machine to detect the sizes of the following originals, so select the paper size manually.

- Originals with indexes, tags, or other projecting parts
- Transparent originals such as OHP transparencies or translucent paper
- Dark originals with many letters and drawings
- Originals which partially contain a solid image
- Originals which have solid images at their edges

Missing Image Area

❖ Exposure glass

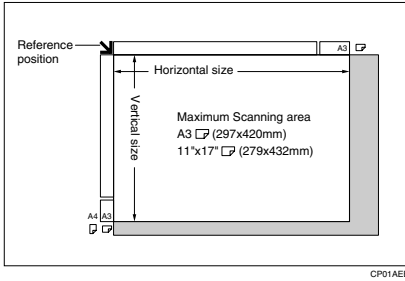

❖ Document feeder

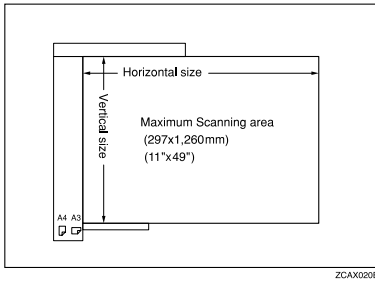



! Limitation

- Even if you correctly set originals in the document feeder or on the exposure glass, 3mm (0.1") margins on all four sides of the original might not be copied.
- There are cases where the paper will be fed diagonally when a paper size of 433mm or larger is used. Ensure that the paper is set in place it is fed straight.
- The system length setting is at its maximum value when set at 1260mm (49").

Copy Paper

Recommended Paper Sizes and Types

The following limitations apply to each tray:

	Metric Version	Inch Version	Paper Weight	Paper Capacity
Tray 1 *4 Tray 2 *4	A3☐, B4☐, A4☐☐, B5☐☐, <A5☐☐>, <11" × 17"☐☐>, <8 ¹ / ₂ " × 14"☐☐>, <8 ¹ / ₂ " × 11"☐☐>, <8" × 13"☐☐>, <8 ¹ / ₂ " × 13"☐☐>, <8 ¹ / ₄ " × 13"☐☐>, <8 ¹ / ₄ " × 14"☐☐>, <11" × 14"☐☐>, <7 ¹ / ₄ " × 10 ¹ / ₂ "☐☐>, <8" × 10 ¹ / ₂ "☐☐>, <5 ¹ / ₂ " × 8 ¹ / ₂ "☐☐>	<A3☐, B4☐☐>, A4☐☐, <B5☐☐, A5☐☐>, 11" × 17"☐☐, 8 ¹ / ₂ " × 14"☐☐, 8 ¹ / ₂ " × 11"☐☐, <8" × 13"☐☐>, 8 ¹ / ₂ " × 13"☐☐, <8 ¹ / ₄ " × 13"☐☐>, <8 ¹ / ₄ " × 14"☐☐>, <11" × 14"☐☐>, <7 ¹ / ₄ " × 10 ¹ / ₂ "☐☐>, <8" × 10 ¹ / ₂ "☐☐>, <5 ¹ / ₂ " × 8 ¹ / ₂ "☐☐>	64-105g/m ² (17-28lb.)	500 sheet
	 Note <input type="checkbox"/> When selecting paper sizes in parentheses, set the paper size selector knob to the ✱ mark. ⇒ P.188 "Changing the Paper Size" <input type="checkbox"/> You have to specify the paper size with the User Tools (System Settings). See "Paper Size Setting" in the SystemSettings manual.	 Note <input type="checkbox"/> When selecting paper sizes in parentheses, set the paper size selector knob to the ✱ mark. ⇒ P.188 "Changing the Paper Size" <input type="checkbox"/> You have to specify the paper size with the User Tools (System Settings). See "Paper Size Setting" in the SystemSettings manual.		

Tray 3 ^{*4} Tray 4 ^{*4} OPTION		A3☐, B4☐, A4☐☐, B5☐☐, A5☐, 11" × 17"☐, 8 ¹ / ₂ " × 14"☐, 8 ¹ / ₂ " × 11"☐☐, 8" × 13"☐, 8 ¹ / ₄ " × 13"☐, 8 ¹ / ₄ " × 14"☐, 11" × 14"☐, 7 ¹ / ₄ " × 10 ¹ / ₂ "☐☐, 8" × 10 ¹ / ₂ "☐☐, 5 ¹ / ₂ " × 8 ¹ / ₂ "☐	A3☐, B4☐, A4☐☐, B5☐☐, A5☐, 11" × 17"☐, 8 ¹ / ₂ " × 14"☐, 8 ¹ / ₂ " × 11"☐☐, 8" × 13"☐, 8 ¹ / ₄ " × 13"☐, 8 ¹ / ₄ " × 14"☐, 11" × 14"☐, 7 ¹ / ₄ " × 10 ¹ / ₂ "☐☐, 8" × 10 ¹ / ₂ "☐☐, 5 ¹ / ₂ " × 8 ¹ / ₂ "☐	60-105g/m ² (16-28lb.)	500 sheet
Bypass Tray ^{*2 *3 *4}	Standard Size	A3☐, B4☐, A4☐, B5☐, A5☐, Postcard☐, 11" × 17"☐, 8 ¹ / ₂ " × 14"☐, 8 ¹ / ₂ " × 11"☐☐, 5 ¹ / ₂ " × 8 ¹ / ₂ "☐, 7 ¹ / ₄ " × 10 ¹ / ₂ "☐☐, 8" × 13"☐, 8 ¹ / ₂ " × 13"☐, 8 ¹ / ₄ " × 13"☐, 11" × 14"☐, 11" × 15"☐, 10" × 14"☐, 10" × 15"☐, 8 ¹ / ₄ " × 14"☐, 8" × 10 ¹ / ₂ "☐☐, 8" × 10"☐☐	A3☐, B4☐, A4☐, B5☐, A5☐, Postcard☐, 11" × 17"☐, 8 ¹ / ₂ " × 14"☐, 8 ¹ / ₂ " × 11"☐☐, 5 ¹ / ₂ " × 8 ¹ / ₂ "☐, 7 ¹ / ₄ " × 10 ¹ / ₂ "☐☐, 8" × 13"☐, 8 ¹ / ₂ " × 13"☐, 8 ¹ / ₄ " × 13"☐, 11" × 14"☐, 11" × 15"☐, 10" × 14"☐, 10" × 15"☐, 8 ¹ / ₄ " × 14"☐, 8" × 10 ¹ / ₂ "☐☐, 8" × 10"☐☐	52-90.2g/m ² (14-24lb.)	50 sheet
				91-163g/m ² (24-43lb.) ^{*5}	25 sheet
	Custom size	Vertical: 100~297mm Horizontal: 148~600mm	Vertical: 4.0"~11.7" Horizontal: 5.9"~23.6"	52-90.2g/ m ² (14- 24lb.)	50 sheet
				91-163g/m ² (24-43lb.) ^{*5}	25 sheet
		Postcard, adhesive labels, translucent paper, OHP transparencies			
Large Capacity Tray (LCT) ^{*1 *4} (OPTION)		A4☐, 8 ¹ / ₂ " × 11"☐	A4☐, 8 ¹ / ₂ " × 11"☐	60-105g/m ² (16-28lb.)	1500 sheet

^{*1} The paper tray fence is fixed. If you wish to change the size of paper set in this tray, contact your service representative.

^{*2} If you wish to copy onto custom size paper, set the paper in the bypass tray and specify the size. ⇒ P.58 "Copying from the Bypass Tray".

^{*3} If you wish to copy onto OHP transparencies or thick paper, select OHP or Thick Paper mode. ⇒ P.60 "When Copying onto OHP Transparencies or Thick Paper".

^{*4} When setting copy paper, make sure that the stack height does not exceed the limit mark. The maximum number of sheets you can set at a time depends on the paper thickness and condition.

^{*5} If you wish to copy onto thick (128g/m², 34 lb or heavier) paper, select Thick Paper mode. ⇒ "Special Paper Indication" in the System Settings manual.

Important















- ❑ If you use damp or curled paper, a misfeed might occur. In this case, try turning over the paper stack in the paper tray. If there is no improvement, change to paper with less curl.

Note

- ❑ When you use the bypass tray, it is recommended to set the copy paper direction to .
- ❑ Postcards should be fed from the bypass tray.
- ❑ If you load paper of the same size and in the same direction in two or more trays, the machine automatically shifts to another tray when the tray in use runs out of paper. This function is called Auto Tray Switching. (However, this only true if the Paper Type is recycled or special paper, and the setting for the other trays are the same.) This saves interrupting a copy run to replenish paper when making a large number of copies. ⇒ P.38 "Selecting Copy Paper", ⇒ P.206 "Auto Tray Switching"
- ❑ If you select Thick Paper mode, copying speed might be reduced.

Direction-fixed paper or 2-sided paper

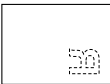
The direction-fixed (top to bottom) or 2-sided paper (letterhead paper, punched paper, or copied paper, e.g.) might not be printed correctly depending on how the originals and paper are set in place. Set "Letterhead setting" of system settings and then set the original and paper as shown below. ⇒ "Letterhead Setting" in ⇒ P.226 "Input/Output"

Copy Mode		Paper Tray	Large Capacity Tray	Bypass Tray	
				Original on the exposure glass	Original on the document feeder
Paper setting direction 	1 Sided				
	2 Sided			—	—
Paper setting direction 	1 Sided				
	2 Sided			—	—

GCAH100E

Non-recommended Paper

CAUTION:

- *Do not use aluminum foil, carbon paper, or similar conductive paper to avoid a fire or equipment failure.*

Important

- Do not use any of the following kinds of paper or a fault might occur.
 - Thermal fax paper
 - Art paper
 - Aluminum foil
 - Carbon paper
 - Conductive paper
 - Colored OHP transparencies
 - Paper with perforated lines
 - Hemmed paper

Note

- Do not use the following kinds of paper or a misfeed might occur.
 - Bent, folded, or creased paper
 - Torn paper
 - Slippery paper
 - Perforated paper
 - Rough paper
 - Thin paper that has low stiffness
 - Paper with much paper dust on its surface
- If you make a copy on rough grain paper, the copy image might be blurred.

Paper Storage

Note

- When storing paper, the following precautions should always be followed:
 - Do not store paper where it will be exposed to direct sunlight.
 - Avoid storing paper in humid areas (humidity: 70% or less).
 - Store on a flat surface.
- Keep open reams of papers in the package, and store as you would unopened paper.
- Under high temperature and high humidity, or low temperature and low humidity conditions, store paper in a vinyl bag.

Toner

Handling Toner

WARNING:

- *Do not incinerate used toner or toner containers. Toner dust might ignite when exposed to an open flame. Dispose of used toner containers in accordance with local regulations for plastics.*

CAUTION:

- *Keep toner (used or unused) and toner containers out of reach of children.*

CAUTION:

- *Our products are engineered to meet high standards of quality and functionality, and we recommend that you only use the expendable supplies available at an authorized dealer.*

Important

- If you use toner other than the recommended type, a fault might occur.

Reference

If you want to add toner. ⇒ P.178 “ Adding Toner”

Toner Storage

When storing toner, the following precautions should always be followed:

- Store toner containers in a cool, dry place free from direct sunlight.
- Store on a flat surface.

Used Toner

Note

- Used toner cannot be re-used.

2. Copying

Basic Procedure

- 1 Make sure that the machine is in Copy mode.

If the machine is not in Copy mode, press the **[Copy]** key.

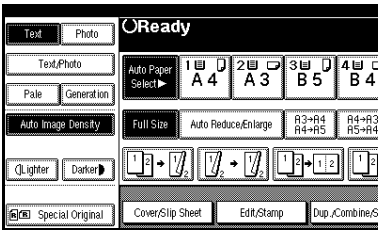

- 2 When the machine is set for the user code, enter the user code with the number keys and then press the **[#]** key.

Reference

⇒ P.66 "Other Functions".

- 3 Make sure that there are no previous settings remaining.

Note

- To clear settings, press the **[Clear Modes]** key.

- 4 Set your originals.

Reference

⇒ P.29 "Setting Originals".

- 5 Set your desired settings.

- 6 Enter the number of copies required with the number keys.

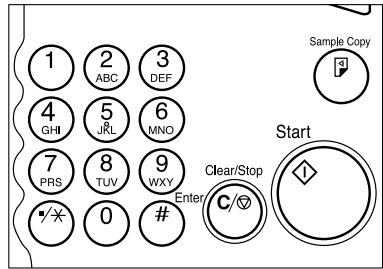

Note

- The maximum copy quantity can be set between 1 and 999 (default: 999).
- To change the number entered, press the **[Clear/Stop]** key and enter the new number.

- 7 Press the **[Start]** key.

The machine starts copying.

Note

- When you set originals on the exposure glass, press the **[#]** key after all originals are scanned.
- Copies are delivered face down.
- To stop the machine during the multi-copy run, press the **[Clear/Stop]** key.
- To return the machine to the initial condition after copying, press the **[Clear Modes]** key.

System Reset

The machine returns to its initial condition automatically when your job is finished, after a certain period of time. This function is called "System Reset".

Note

- You can change the System Reset time. ⇒ "System Reset Timer" in "System Settings manual".

Auto Off

The machine turns itself off automatically after your job is finished, after a certain period of time. This function is called "Auto Off".

Note

- You can change the Auto Off time. ⇒ "Auto Off Timer" in the System Settings manual.
- Auto Off time function will not operate in the following:
 - When the warning message is displayed.
 - When the service call message is displayed.
 - When the paper is jammed.
 - When the cover is open.
 - When "Adding Toner" message is displayed.
 - When the toner is being replenished.
 - When the User Tools/Counter screen is displayed.
 - When fixed warm-up is in progress.
 - When the facsimile, printer or other functions are operating.

- When operations have been suspended during printing.
- When the handset is in use.
- When the On-hook dialing function is in use.
- When a recipient is being registered in the address list or group dial list.
- When the Data In indicator goes on or blinking.
- When the sample print/confidential print screens are displayed.

Setting Originals

Limitation

- ❑ Set originals after correction fluid and ink has completely dried. Not taking this precaution could mark the exposure glass and cause marks to be copied.

Note

- ❑ Basically originals should be aligned to the rear left corner. However, some copy functions may produce different results depending on the direction of the originals. For details, see the explanations of each function.

	Original	Exposure glass	Document feeder
Standard			
90° Turn			

GG8SET1E

Reference

⇒ P.18 "Originals".

Setting Originals on the Exposure Glass

- 1 Lift the platen cover or the document feeder.

Important

- ❑ Do not open the document feeder with a force. Otherwise, the cover of the document feeder might open or be damaged.

Note

- ❑ Be sure to open the document feeder by more than 30°. Otherwise the original size might not be detected correctly.

- 2 Set the original face down on the exposure glass. The original should be aligned to the rear left corner.

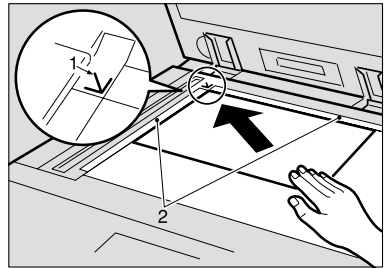

ZDSH065J

- 1: Reference mark
2: Scale

Note

- ❑ Start with the first page to be copied.

- 3 Lower the platen cover or document feeder.

2

Setting Originals in the Document Feeder

Note

- The last page should be on the bottom.
- Do not stack originals beyond the limit mark on the side fence of the document feeder.
- The original might become dirty if it is written with a pencil or similar tools.

Reference

Regarding originals that the document feeder can handle. ⇒ P.18 "Originals".

- 1** Set the aligned originals face up into the document feeder.

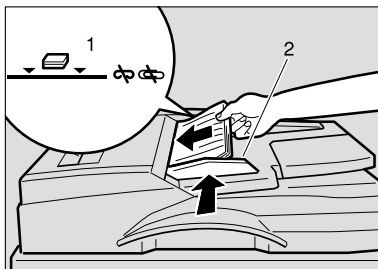

ZDSH060J

- 1: Limit mark
- 2: Document guide

Note

- Straighten curls in the originals before setting them in the document feeder.
- To avoid a multi-sheet feed, shuffle the originals before setting them in the document feeder.

Original Orientation

You can set the original orientation separately in the following ways.

This function is useful for copying torn originals or large originals.

◆ Standard Orientation

Select this function when the original direction is the same as the copy paper direction.

◆ 90° Turn

This function rotates the copy image by 90°.

Use this function when you want to copy onto A3, B4, 11" × 17" paper.

- 1** Press the [Special Original] key.

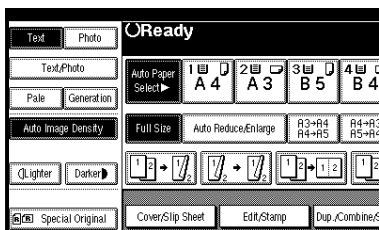





- 2** Select the original orientation.

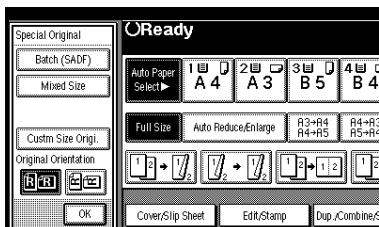

Standard Orientation

- 1** Make sure that the  key is selected.



90° Turn

When you want to copy A3 , B4  or 11" × 17"  size originals, set your original in the landscape orientation and then press the  key. The machine rotates the original image and you can make copies as you wish. This is useful for copying large originals with the Staple, Punch, Duplex, Combine or Stamp functions.

For example, if you want to copy A3  or 11" × 17"  originals with for the Staple function configured as shown below:

Note

- It is recommended to use this function together with the Auto Paper Selector Preset Reduce/Enlarge function.

1 Press the key.

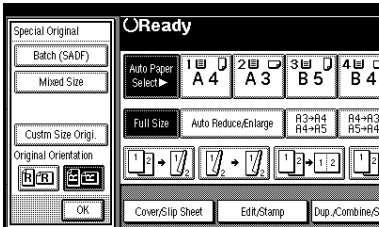

3 Press the [OK] key.

Setting Special Originals

Use this function when you want to use Batch, Mixed Sizes, or when you select the original orientation.

Batch mode

Up to 80 standard originals can be set in the document feeder at a time.

Important

- When setting special originals such as translucent paper, set them one by one.

Note

- The [Batch] key can be change to the [SADF] key. ⇒ P.226 "Switch to Batch (SADF)".
- In Batch mode, even when one original is set in the document feeder, the original is automatically fed each time it is set.

1 Press the [Special Original] key.

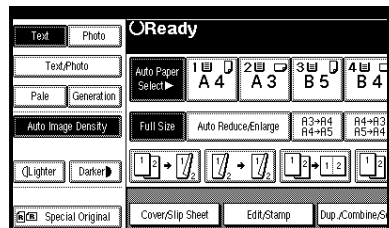

2 Press the [Batch] key.

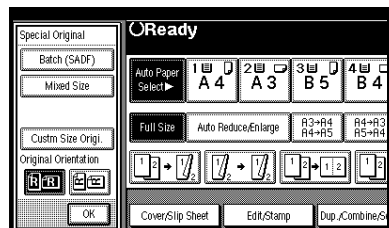

3 Press the [OK] key.

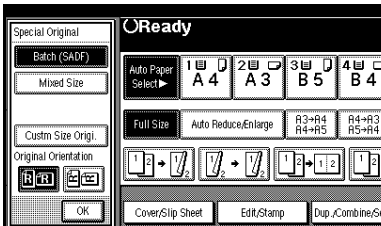

4 Set your originals, then press the [Start] key.

5 After all the previously set originals are fed, set the next originals.

The second and subsequent originals can be fed automatically without pressing the [Start] key.

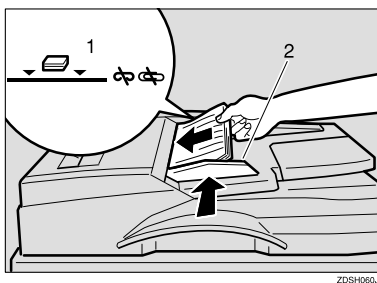

1: Limit mark

2: Document guide

Note

- When the Sort, Combine or Duplex function has been set, press the [#] key after all originals are scanned.

6 Press the [Start] key.

Mixed Size mode

When originals of different sizes are set on the document feeder at a time, the machine automatically checks the size of the originals and makes copies.

Limitation

- When setting originals of different sizes on the document feeder and making copies without using Mixed Sizes mode, parts of the original image might not be copied, or paper might be jammed.
- The weight of originals that can be set with this function is 52 – 81g/m², 14 – 20 lb.
- The original sizes that can be set with this function are as follows:

Metric version	A3☐, B4☐, A4☐☐, B5☐☐
Inch version	11"×17"☐, 8 ¹ / ₂ "×14"☐, 8 ¹ / ₂ "×11"☐☐, 5 ¹ / ₂ "×8 ¹ / ₂ "☐☐

- For smaller originals, the copy image might be slanted since the originals might not be correctly aligned with the original guide.
- Copying speed and scanning speed will be reduced.

Note

- This key is not used when sending a fax message in Mixed size originals. Switch to Facsimile mode and set Mixed size originals. Refer to the Facsimile Reference manual.

- 1** Press the [Special Original] key.

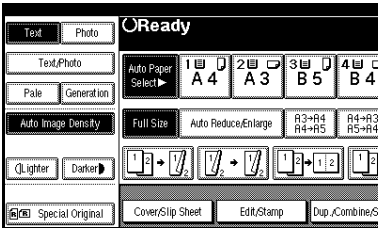

- 2** Press the [Mixed size] key.

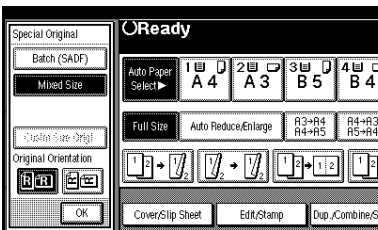

- 3** Press the [OK] key.

- 4** Align the rear and left edges of the originals as shown in the illustration.

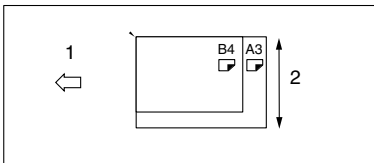

CP19AE

- 1: Set into the document feeder.
2: Vertical size

- 5** Adjust the guide to the widest original size.
6 Set the aligned originals face up into the document feeder.
7 Press the [Start] key.

Setting Custom Size Originals

When setting custom size originals in the document feeder, specify the size of the originals.

Limitation

- The paper size that can be set with this function is vertical 128-297mm (5" – 11"), horizontal 128-1,260mm (5" – 49").

- 1** Press the [Special Original] key.

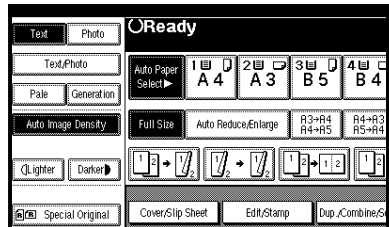

- 2** Press the [Custom Size Orig.] key.

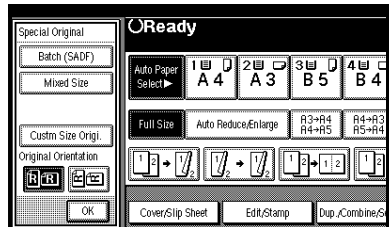

- 3** Enter the horizontal size of the original with the Number keys, then press the [#] key.

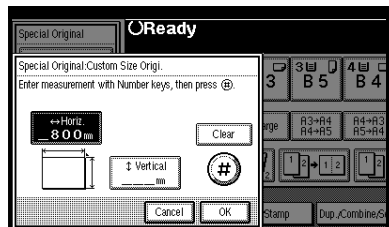

Note

- If you make a mistake, press the [Clear] or [Clear/Stop] key, and then enter the value again.

2

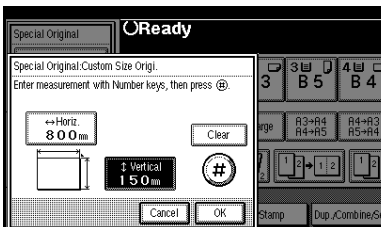

- 4** Enter the vertical size of the original with the Number keys, then press the [#] key.



- 5** Press the [OK] key.
- 6** Set your originals, then press the [Start] key.

Basic Functions

The following basic functions are explained in this section.

- ❖ **Adjusting Copy Image Density**
Auto and Manual Image Density
- ❖ **Selecting Original Type Setting**
Text, Text-Photo, Photo, Pale, Generation Copy
- ❖ **Selecting Copy Paper**
Auto Paper Select and Manual Paper Select
- ❖ **Auto Reduce/Enlarge**
The machine can choose an appropriate reproduction ratio based on the paper and original sizes you select.
- ❖ **Sort**
Copies can be assembled as sets in sequential order.
- ❖ **Rotate Sort**
Every other copy set is rotated by 90°   and delivered to the copy tray.
- ❖ **Stack (The optional Bridge unit and the optional finisher are required for this function)**
Copies can be assembled with each page set.
- ❖ **Staple (The optional Bridge unit and the optional finisher are required for this function)**
Each copy set can be stapled together.

- ❖ **Punch (The optional Bridge unit and the optional 2 Tray finisher are required for this function)**

This function is used to make punch holes in copies.

Note

- You can select functions to be activated when System Reset is turned on, when Energy Saver is turned off, or after the machine is powered on.
- You can change default settings for basic functions. ⇒ “Settings You Can Change with the User Tools” in System Settings manual.

Adjusting Copy Image Density

You can adjust the copy image density to match your originals.

There are three types in this function:

- ❖ **Auto Image Density**
The machine automatically adjusts the image density.
- ❖ **Manual Image Density**
If you require darker or lighter copies, adjust the image density yourself.
- ❖ **Combined Auto and Manual Image Density**
Use when copying originals with a dirty background (such as newspapers). You can adjust the foreground density while leaving the background unchanged.

Auto Image Density

- 1 Make sure that the [Auto Image Density] key is selected.

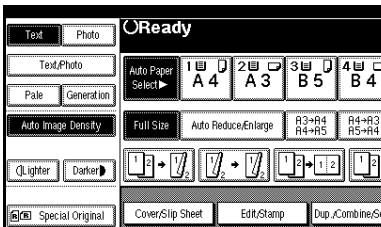

Note

- If the [Auto Image Density] key is not selected, press the [Auto Image Density] key.
- If you do not wish to set any other functions, press the [Start] key to start copying.

Manual Image Density

- 1 Press the [Auto Image Density] key to cancel it.
- 2 Press the [Lighter] or [Darker] key to adjust the image density.

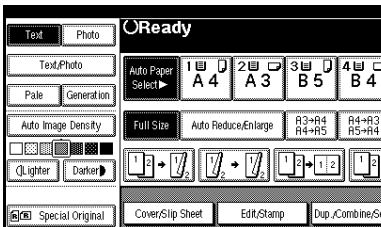

Note

- If you do not wish to set any other functions, press the [Start] key to start copying.

Combined Auto and Manual Image Density

- 1 Make sure that the [Auto Image Density] key is selected.
- 2 Press the [Lighter] or [Darker] key to adjust the density.

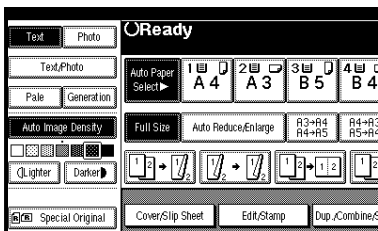

Note

- If you do not wish to set any other functions, press the [Start] key to start copying.

Selecting Original Type Setting

Select one of the following types to match your originals:

- ◆ **Text**
Select this mode when your originals contain only letters (no pictures).
- ◆ **Text-Photo**
Select Text-Photo when your originals contain photographs or pictures with letters.
- ◆ **Photo**
Delicate tones of photographs and pictures can be reproduced with this mode.

❖ Pale

Select this mode for originals that have lighter lines written in pencil, or for faint copied slips. The faint lines will be clearly copied.

❖ Generation Copy

If your originals are copies (generation copies), the copy image can be reproduced sharply and clearly.

📝 Note

- You can directly display the **[Original Mode]** key on the copy original display.
- You can adjust the quality level for each original type.

1 Press the appropriate key to select the original type.

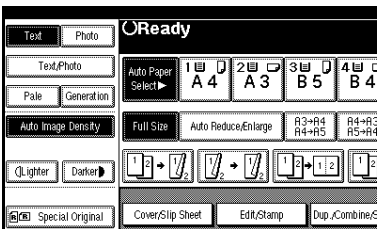

📝 Note

- If “Yes” has been selected in “Original Mode Display” of the User Tools, press the **[Original Mode]** key to select the original type, then press the **[OK]** key. ⇒ “Original Mode Display” in P.206 “General Features ¹/₄”.

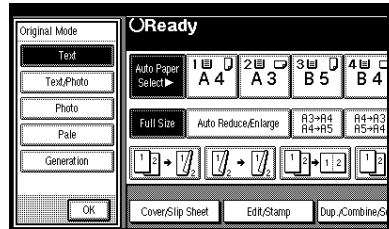

- If you do not wish to set any other functions, press the **[Start]** key to start copying.

Selecting Copy Paper

There are two ways to select copy paper:

❖ Auto Paper Select

The machine selects a suitable size of copy paper automatically based on the original size and the reproduction ratio. ⇒ P.40 "Rotated copy".

❖ Manual Paper Select

Choose the tray containing the paper you wish to copy onto: Paper Tray, Bypass Tray or large capacity tray (LCT).

Reference

⇒ P.58 "Copying from the Bypass Tray".

! Limitation

- Auto Paper Select mode is intended for normal and recycled paper.
- If you set all the paper trays other than "No Display" or "Recycled Paper", you cannot use Auto Paper Select.

Note

- See the following table for possible copy paper sizes and directions with Auto Paper Select (when copying at a ratio of 100%):

❖ Metric version

Where Original Is Set	Paper Size and Direction
Exposure glass	A3□, B4□, A4□□, B5□□
Document feeder	A3□, B4□, A4□□, B5□□, A5□□, 11" × 17"□, 8 ¹ / ₂ " × 11"□□

❖ Inch version

Where Original Is Set	Paper Size and Direction
Exposure glass	11" × 17"□, 8 ¹ / ₂ " × 14"□, 8 ¹ / ₂ " × 11"□□
Document feeder	A4□□, 11" × 17"□, 8 ¹ / ₂ " × 14"□, 8 ¹ / ₂ " × 11"□□, 5 ¹ / ₂ " × 8 ¹ / ₂ "□□

- For some originals, the original size might not be detected correctly. ⇒ P.19 "Sizes difficult to detect".
- When you set special paper, such as recycled paper, in the paper tray, you can have the paper type shown on the display. ⇒ "Special Paper Indication" in the System Settings manual.

Auto Paper Select

- 1 Make sure that the [Auto Paper Select] key is selected.

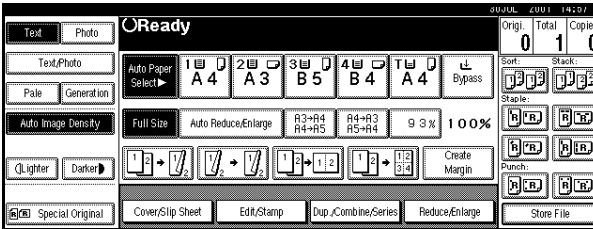

Note

- If the [Auto Paper Select] key is not selected, press the [Auto Paper Select] key.
- If you do not wish to set any other functions, press the [Start] key to start copying.
- If “Yes” has been selected in “Original Mode Display” of the User Tools, press the [Auto Paper Select] key.
- The tray with the key mark will not be automatically selected.

Manual Paper Select

- 1 Select the paper tray, bypass tray or large capacity tray (LCT).

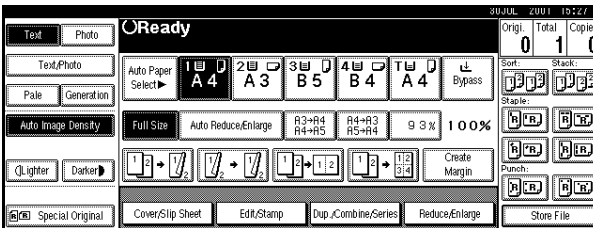

Note

- If you do not wish to set any other functions, press the [Start] key to start copying.



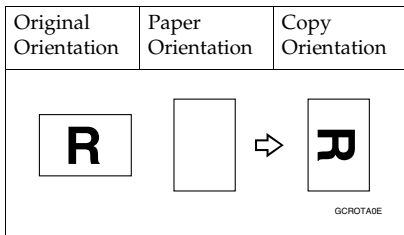

Rotated copy

If the direction in which your original is set (landscape or portrait) is different from that of the paper you are copying onto, this function rotates the original image by 90° and fits it on the copy paper. This function works when Auto Paper Select or Auto Reduce/Enlarge is selected. ⇒ “Auto Paper Select” in P.38 “Selecting Copy Paper” and ⇒ P.41 “Auto Reduce/Enlarge”.



Limitation

- The default setting for “Auto Tray Switching” is “With Image Rotation” You cannot use the Rotated Copy function because this setting is changed to “Without Image Rotation” or “Off”.
- You cannot use the Rotated Copy function when enlarging onto B4 or A3 size paper. In this case, set your original in the landscape direction.

	Original Size and Direction		Copy Paper Size and Direction
You cannot rotate:	A4, B5, or A5 portrait  <small>GCROTAGE</small>	When enlarging to →	B4, A3  <small>GCROTAGE</small>
However, you can rotate:	A4, B5, or A5 landscape  <small>GCROTAGE</small>	When enlarging to →	B4, A3  <small>GCROTAGE</small>

- You cannot use the Rotated Copy function when “Top Slant”, “Left 2” or “Saddle Stitch” is selected for stapling or if the Punch function is selected when using the 2 Tray finisher. ⇒ P.47 “Staple” and ⇒ P.54 “Punch”.
- You cannot use the Rotate Copy function if the Staple function is selected when using the 1000-sheet finisher.

Auto Reduce/Enlarge

The machine can choose an appropriate reproduction ratio based on the paper and original sizes you select.

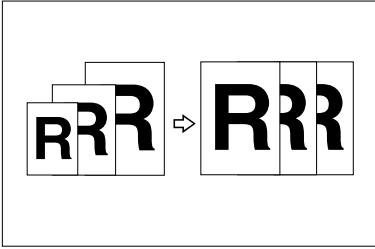

Limitation

- You cannot use the bypass tray with this function.

Note

- When you use Auto Reduce/Enlarge, see the following table for possible original sizes and directions:

◆ Metric version

Where Original Is Set	Original Size and Direction
Exposure glass	A3☐, B4☐, A4☐☐, B5☐☐
Document feeder*1	A3☐, B4☐, A4☐☐, B5☐☐☐, A5☐☐, B6☐☐☐, 11" × 17"☐, 8 ¹ / ₂ " × 11"☐☐

*1 You cannot scan 2-sided B6 originals.

◆ Inch version

Where Original Is Set	Original Size and Direction
Exposure glass	11" × 17"☐, 8 ¹ / ₂ " × 14"☐☐, 8 ¹ / ₂ " × 11"☐☐
Document feeder*1	A4☐☐, 11" × 17"☐☐, 8 ¹ / ₂ " × 14"☐☐, 8 ¹ / ₂ " × 11"☐☐☐, 5 ¹ / ₂ " × 8 ¹ / ₂ "☐☐

*1 You cannot scan two sided B6 originals.

- The reproduction ratios the machine will select are 25 – 400%.
- For some originals, the original size might not be detected correctly. ⇒ P.19 "Sizes difficult to detect".
- You can set originals of different sizes in the document feeder at a time. ⇒ P.32 "Mixed Size mode".
- You cannot use the Rotate function when enlarging B4 or A3 originals. When enlarging on to B4 or A3 size copy paper, set the original in the ☐ direction.

1 Press the [Auto Reduce/Enlarge] key.

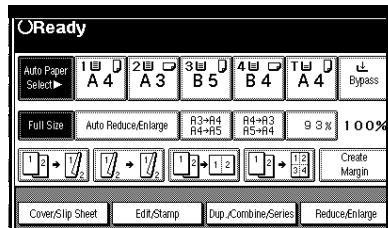

2 Select the paper tray.

Note

- If you do not wish to set any other functions, press the [Start] key to start copying.

Sort/Stack/Staple

The machine can scan your originals into memory and automatically sort the copies.

❖ Sort

- Sort
- Rotate Sort
- Shift sort (the optional finisher and the optional Bridge unit are required)

❖ Stack

- Stack
(the optional finisher and the optional Bridge unit are required)

❖ Staple (the optional finisher and the optional Bridge unit are required)

With 1000-Sheet Finisher

- Top Slant
With 2 Tray Finisher

- Top
- Top Slant
- Bottom
- Top 2

📍 Limitation

- ❑ You cannot use the bypass tray with this function.
- ❑ The maximum capacity for Sort, Rotate Sort, and Stack with A5 ☐ is 100 sheets.

















📎 Note

- ❑ When the number of copies exceeds the tray capacity, remove copies from the tray.
- ❑ The maximum tray capacity is as follows.

❖ Metric version

Internal tray	<ul style="list-style-type: none"> • B4☐ or larger: 250 sheets (80g/m²) • A4☐ or smaller: 500 sheets (80g/m²)
Internal tray 2 (1 bin tray)	125 sheets (80g/m ²)
External tray	125 sheets (80g/m ²)
1000-Sheet Finisher	<ul style="list-style-type: none"> • B4☐ or larger: 500 sheets (80g/m²) • A4☐ or smaller: 1,000 sheets (80g/m²)
2 Tray Finisher	Finisher shift tray 1 <ul style="list-style-type: none"> • A3☐, B4☐: 250 sheets (80g/m²) • A4☐☐, B5☐☐, A5☐: 500 sheets (80g/m²) • A5☐: 100 sheets (80g/m²)
	Finisher shift tray 2 <ul style="list-style-type: none"> • A3☐, B4☐, A4☐, B5☐☐: 750 sheets (80g/m²) • A4☐: 2,000 sheets (80g/m²) • A5☐: 500 sheets (80g/m²) • A5☐: 100 sheets (80g/m²)

◆ Inch version

Internal tray	<ul style="list-style-type: none"> • 8¹/₂" × 14"  or larger: 250 sheets (20 lb.) • 8¹/₂" × 11"  or smaller: 500 sheets (20 lb.)
Internal tray 2 (1 bin tray)	125 sheets (20 lb.)
External tray	125 sheets (20 lb.)
1000-Sheet Finisher	<ul style="list-style-type: none"> • 8¹/₂" × 14"  or larger: 500 sheets (20 lb.) • 8¹/₂" × 11"  or smaller: 1,000 sheets (20 lb.)
2 Tray Finisher	Finisher Shift Tray 1 <ul style="list-style-type: none"> • 11" × 17" , 8¹/₂" × 14" : 250 sheets (20 lb.) • 8¹/₂" × 11"   : 500sheets (20 lb.) • 5¹/₂" × 8¹/₂"   : 100sheets (20 lb.)
	Finisher Shift Tray 2 <ul style="list-style-type: none"> • 11" × 17" , 8¹/₂" × 14" , 8¹/₂" × 11" : 750 sheets (20 lb.) • 8¹/₂" × 11"  : 2,000sheets (20 lb.) • 5¹/₂" × 8¹/₂"   : 100sheets (20 lb.)

Sort

Copies can be assembled as sets in sequential order.





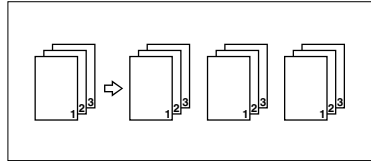





◆ Sort

Copies can be assembled as sets in sequential order.





Note

- The paper sizes that can be used in the Sort function are as follows:

Metric version	A3  , B4  , A4  , B5  , A5 
Inch version	11" × 17"  , 8 ¹ / ₂ " × 14"  , 8 ¹ / ₂ " × 11"   , 5 ¹ / ₂ " × 8 ¹ / ₂ "  

◆ Rotate Sort

Every other copy set is rotated by 90°   and delivered to the copy tray.

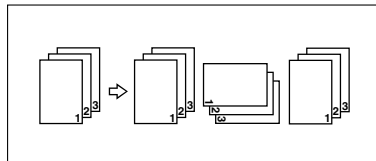

Note

- When the optional finisher is installed, you can switch to or from the Rotate Sort function with the User Tools. ⇒ "Select Stack or Rotate sort" in P.226 "Input/Output".

- ❑ The paper sizes that can be used in the Rotate Sort function are as follows:

Metric version	A4 , B5
Inch version	8 1/2" × 11"

- ❑ To use the Rotate Sort function, two paper trays identical in size and different in direction () are required.

Reference

For the paper capacity of the optional finishers, ⇒ P.238 "1000-Sheet Finisher (Option)", ⇒ P.239 "2 Tray Finisher (Option)".

When using the Rotate Sort, Punch or Staple functions, the capacity may be reduced.

❖ Shift Sort

- 1000-Sheet/2 Tray Finisher
The shift tray moves backward or forward each time the copies of one set or those of each job are delivered, causing the next copy to shift when delivered so that you can differentiate each set or job.

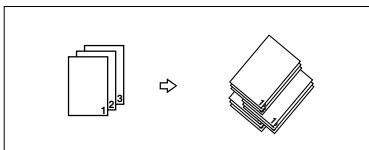

Note

- ❑ The paper sizes that can be used in the Sort function are as follows:

	1000-Sheet Finisher	2 Tray Finisher
Metric version	A3 , B4 , A4 , B5 , A5 , B6 , A6	A3 , B4 , A4 , B5 , A5
Inch version	11" × 17" , 8 1/2" × 14" , 8 1/2" × 11" , 5 1/2" × 8 1/2"	11" × 17" , 8 1/2" × 14" , 11" , 5 1/2" × 8 1/2"

1 Press the [Sort] or [Rotate Sort] key.

❖ When the finisher is not installed

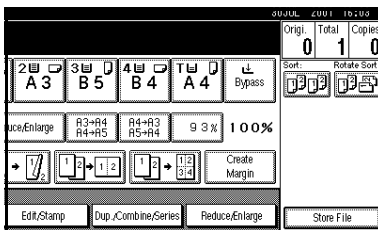

❖ When the 1000-Sheet Finisher is installed

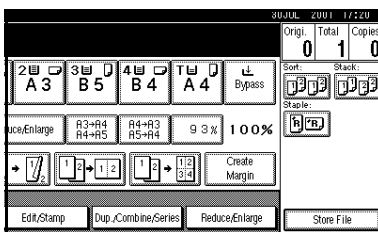

◆ When the 2 Tray Finisher is installed

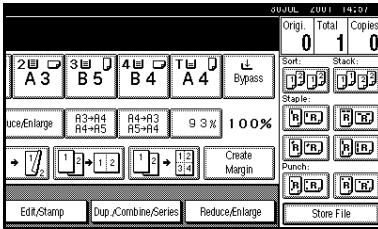

Note

- When the optional finisher is installed, use the User Tools to display **[Rotate Sort]**. ⇒ “Select Stack Function” in P.226 “Input/Output”.

2 Enter the number of copy sets with the number keys.

Limitation

- The maximum number of sets is 999.

Note

- To change the entered number, press the **[Clear/Stop]** key.

3 Set your originals, then press the **[Start]** key.

When setting a stack of originals in the document feeder

1 Set a stack of originals in the document feeder, then press the **[Start]** key.

Note

- The last page should be on the bottom.
- If an original is misfed during sorted copying, reset your originals in the document feeder according to the instructions on the display. The display will indicate the number of scanned originals.

When setting an original on the exposure glass or in the document feeder using Batch mode

Reference

⇒ P.31 “Batch mode”.

1 Set the original, then press the **[Start]** key.

Note

- Start with the first page to be copied.

2 Set the next original. When it is placed on the exposure glass, press the **[Start]** key.

Note

- Set the original in the same direction as the first one.

3 After all originals are scanned, press the **[#]** key.

Stack

Copies can be assembled with each page set.

◆ Shift Stack

- 1000-Sheet/2 Tray-Sheet Finisher
This function groups copies of each page in a multi-page original together. Every other page stack is shifted for ease of separation. The finisher shift tray of the finisher provides this function by sliding from side to side.

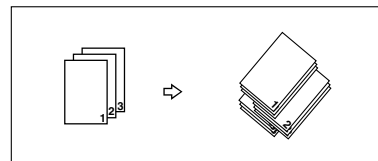

Note

- The paper sizes that can be used in the Stack function are as follows:

	1000-Sheet Finisher	2 Tray Finisher
Metric version	A3, B4, A4, B5, A5	A3, B4, A4, B5, A5
Inch version	11" x 17", 8 1/2" x 14", 8 1/2" x 11", 5 1/2" x 8 1/2"	11" x 17", 8 1/2" x 14", 8 1/2" x 11", 5 1/2" x 8 1/2"

Reference

For the maximum tray capacity of the optional finisher, ⇒ P.238 "1000-Sheet Finisher (Option)", ⇒ P.239 "2 Tray Finisher (Option)".

1 Press the [Stack] key.

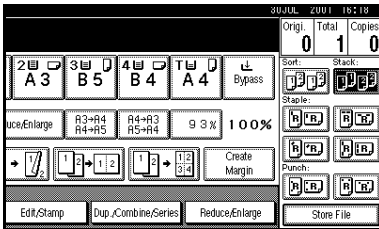

2 Enter the number of copies with the number keys.

Note

- To change the entered number, press the [Clear/Stop] key.

3 Set your originals, then press the [Start] key.

When setting a stack of originals in the document feeder

- Set a stack of originals in the document feeder, then press the [Start] key.

Note

- The last page should be on the bottom.

When setting an original on the exposure glass or in the document feeder using Batch mode

Reference

⇒ P.31 "Batch mode".

- Set the original, then press the [Start] key.

Note

- Start with the first page to be copied.

- Set the next original. When it is placed on the exposure glass, press the [Start] key.

Note

- Set the original in the same direction as the first one.

Staple

The optional finisher and the bridge unit are required to use this function.

Each copy set can be stapled together.

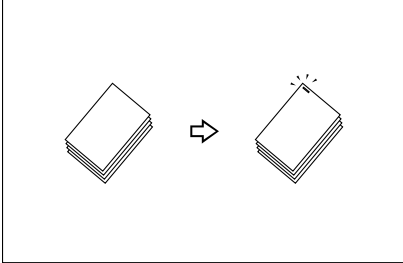

Limitation

- You cannot use the following paper in this function:
 - Postcards
 - Translucent paper
 - OHP transparencies
 - Adhesive labels
 - Curled paper
 - Low stiffness paper
 - Paper of different vertical sizes

Note









- For this mode, the following limitation applies. When the number of copies exceeds the tray capacity, copying stops. In this case, remove the copies from the shift tray and then resume copying.

Metric version

	With 1000-Sheet Finisher	With 2 Tray Finisher
Paper size	A3, B4, A4, B5	A3, B4, A4, B5
Stapler capacity	<ul style="list-style-type: none"> • A4 or smaller: 30 sheets (80g/m²) • B4 or larger: 20 sheets (80g/m²) 	<ul style="list-style-type: none"> • A4 or smaller: 50 sheets (80g/m²) • B4 or larger: 30 sheets (80g/m²) • Mixed Size: 30 sheets (80g/m²)
Shift tray capacity (A4) ^{*1}	1,000 sheets (80g/m ²)	<ul style="list-style-type: none"> • Finisher shift tray 1: 500 sheets (80g/m²) • Finisher shift tray 2: 1,500 sheets (80g/m²)

^{*1} Depending on the number of sheets to be stapled and whether sheets have punched holes or not, the maximum tray capacity might be reduced.







◆ Inch version

	With 1000-Sheet Finisher	With 2 Tray Finisher
Paper size	11" × 17"  , 8 ¹ / ₂ " × 14"  , 8 ¹ / ₂ " × 11"  	11" × 17"  , 8 ¹ / ₂ " × 14"  , 8 ¹ / ₂ " × 11"  
Stapler capacity	<ul style="list-style-type: none"> • 8¹/₂" × 11" or smaller: 30 sheets (20 lb.) • 8¹/₂" × 14" or larger: 20 sheets (20 lb.) 	<ul style="list-style-type: none"> • 8¹/₂" × 11" or smaller: 50 sheets (20 lb.) • 8¹/₂" × 14" or larger: 30 sheets (20 lb.) • Mixed Size: 30 sheets (20lb.)
Shift tray capacity (8 ¹ / ₂ " × 11" ) ^{*1}	1,000 sheets (20 lb.)	<ul style="list-style-type: none"> • Finisher shift tray 1: 500 sheets (20lb.) • Finisher shift tray 2: 1,500 sheets (20lb.)

^{*1} Depending on the number of sheets to be stapled and whether sheets have punched holes or not, the maximum tray capacity might be reduced.

^{*2} If you copy when the paper remains on the tray, the capacity might be reduced.







^{*3} Available staple positions are "Top" and "Bottom".

- In the following cases, the copies will be delivered to the shift tray without stapling.
 - When the number of sheets for one set is over the stapler capacity.
 - When memory reaches 0% during copying.
- When you select Staple, Sort mode is automatically selected.
- When the machine is equipped with the optional 2 Tray Finisher, originals of mixed paper sizes can be stapled, using Auto paper select and Mixed sizes function together. Make sure the appropriate paper sizes are loaded in paper trays. The mixed paper sizes that can be stapled are as follows.
 - A3  and A4 , B4  and B5 , 11" × 17"  and Letter (8¹/₂" × 11") 

🔍 Reference





If you want to add staples, ⇒ P.192 " Adding Staples".



When staple is jammed, ⇒ P.196 " Removing Jammed Staples".

When using 1 Sided → 1 Sided, 1 Sided → 2 Sided, 2 Sided → 1 Sided, 2 Sided → 1 Sided for double copies in Combine mode, select  original for  copy,  original for  copy,  original for  copy.

Stapling position and original setting









Set all the originals in a direction in which they can be read. They will automatically be rotate copied. When there is copy paper that is identical in size and direction as your original, the staple positions are as follows:

When using "1 Sided 2 Pages → Combine 1 Side", "1 Sided 4 Pages → Combine 2 Sided" for double copies in Combine mode, select  original for  copy,  original for  copy.

When using "Top Slant", "Left 2" or "Top 2" with "1 Sided → 1 Sided", "1 Sided → 2 Sided", "2 Sided → 1 Sided", or "2 Sided → 2 Sided" of combine function for double copies, select  original for  copies and  originals for copies.

◆ 1000-sheet Finisher



























When your machine is equipped with the 1000-sheet finisher, the stapling position will be fixed to “Top Slant”.



















		Original setting			Stapling position
			Exposure glass	Document Feeder	
 STAPLEBE	Top Slant				
					

Note

- Original images are not rotated.

◆ 2 Tray Finisher

		Original setting			Stapling position
			Exposure glass	Document Feeder	
 STAPLEAE	Top				
					
 STAPLEBE	Top Slant				
					
 STAPLECE	Bottom		 STAPLE25	 STAPLE26	 STAPLE27
			 STAPLE28	 STAPLE29	 STAPLE30

		Original setting		Stapling position
		Exposure glass	Document Feeder	
 STAPLEDE	Left 2	 		*1 
		  STAPLE31	 STAPLE32	 STAPLE33
 STAPLEEE	Top 2	  STAPLE22ADA	 STAPLE23ADA	*1  STAPLE24ADA
		  STAPLE10ADA	 STAPLE14ADA	 STAPLE20ADA

*1 Available stapling positions except A3, B4, size of paper.

Note

- You cannot change stapling positions during copying.
- When the original image is rotated, the stapling direction turns by 90°.
- By setting orientation of papers and originals, "Blank part will appear. Check orientation." message is displayed. In this case, change the paper orientation.
- The maximum original image size that can be rotated is as follows:

Metric version	A4
Inch version	8 ¹ / ₂ " × 11"

1 Select one of the stapling positions.

◆ 1000-Sheet Finisher

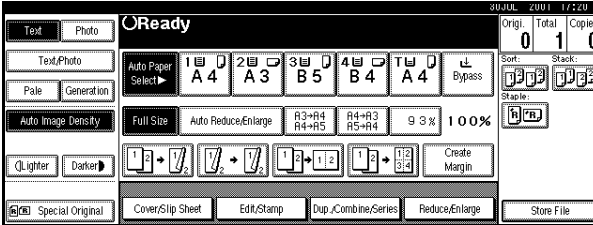

◆ 2 Tray Finisher

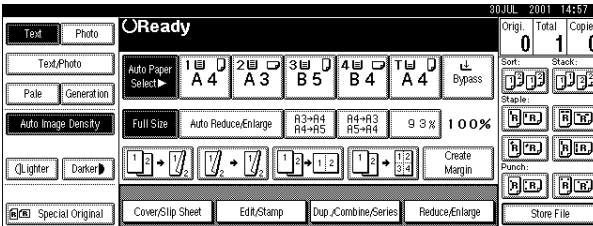

📌 Note

- When you select the stapling position, Sort mode is automatically selected.

🔍 Reference

⇒ P.48 “Stapling position and original setting”

2 Enter the number of copy sets with the number keys.

📌 Note

- To change the entered number, press the **[Clear/Stop]** key.

3 Set your originals, then press the **[Start]** key.

When setting a stack of originals in the document feeder

1 Set a stack of originals in the document feeder, then press the **[Start]** key.

📌 Note

- The last page should be on the bottom.

2

When setting an original on the exposure glass or in the document feeder using Batch mode

Reference

⇒ P.31 “Batch mode”.

- 1 Set the original, then press the **[Start]** key.

Note

- Start with the first page to be copied.

- 2 Set the next original. When it is placed on the exposure glass, press the **[Start]** key.

Note

- Set the original in the same direction as the first one.

- 3 After all originals are scanned, press the **[#]** key.

To Stop Scanning Temporarily

When you are using the Sort, Stack, or Staple function, the originals are scanned into memory.

- 1 Press the **[Clear/Stop]** key to stop originals from being scanned into memory.

To resume scanning

- 1 Press the **[No]** key to resume scanning.

Note

- Scanned images in memory are not cleared.

To clear scanned images of the originals

- 1 Press the **[Yes]** key.

Scanning is stopped with the images cleared.

When Memory Reaches 0%

Scanning will be stopped if the size of scanned image data exceeds memory capacity.

Note

- There is enough memory to store approximate 1,000 originals of A4, 8¹/₂" × 11" size. The number of originals that can be stored in memory varies depending on the memory setting and original type. In addition, the number of originals that can be stored in memory will be reduced when you use other functions.

Reference

Scanning will stop when memory reaches 0% during sorted copying. However, you can change this setting so that all the scanned pages are copied and delivered to the tray first, then the machine automatically continues scanning the remaining originals. ⇒ “Memory Full Auto Scan Restart” in P.226 “Input/Output”.

1 Press the **[Start]** key.

The scanned pages are delivered to the tray. Then, the image data in memory is cleared.

2 Remove the copies and continue copying by following the instructions on the display.

To Remove the Paper from the Staple Unit

If you cancel the stapling copy job in the middle of the job, the paper might be left in the staple unit. In this case, remove the paper from the staple unit.

1 Press the **[Clear Modes]** key to cancel the copy settings.**2** Set the next original, then press the **[Start]** key.

The paper left in the staple unit is automatically delivered, then the next job starts.

 **Note**

- When the paper is not delivered and the message is displayed, follow the instructions on the display to remove the paper.

Punch

The optional 2 tray finisher and the bridge unit are required to use this function.

This function is used to make punch holes in copies.

2

◆ 2 holes

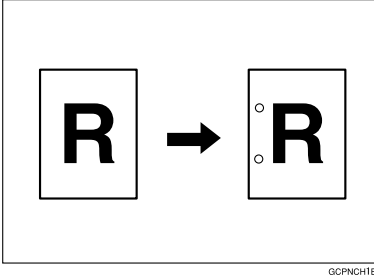

◆ 3 holes

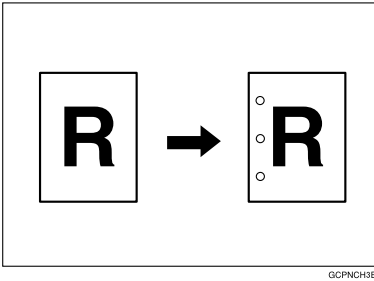



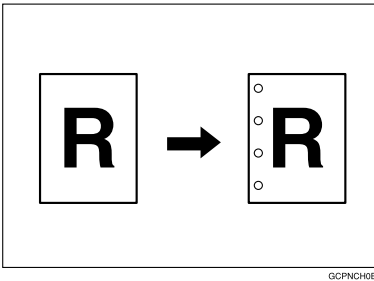





















◆ 4 holes



 **Note**

- When using Punch and Combine, Double Copies, or Auto Reduce/Enlarge, the message "Blank part will appear. Check orientation." may appear because of the orientation of the original and the copy paper. If this occurs, change the orientation of the copy paper.
- The relationship between the direction in which you set the original and the punch hole positions is as follows:

◆ **Punch hole positions**

		Direction in which Original is Set		Punch Hole Positions	
		Exposure glass	Document feeder		
Standard	2 holes				
					
	3 holes				
					
	4 holes				
					

		Direction in which Original is Set		Punch Hole Positions	
		Exposure glass	Document feeder		
90° Turn	2 holes				
	3 holes				
	4 holes				

Punchable paper sizes are as follows:

With 2 Tray Finisher				
Punch kit type				
2 & 4 holes type	2 holes		A3-A5, 11" × 17"-5 ¹ / ₂ " × 8 ¹ / ₂ "	
			A4-A5, 8 ¹ / ₂ " × 11"-5 ¹ / ₂ " × 8 ¹ / ₂ "	
	4 holes		A3, B4, 11" × 17"	
			A4, B5, 8 ¹ / ₂ " × 11"	
4 holes type	4 holes		A3-A5, 11" × 17"-5 ¹ / ₂ " × 8 ¹ / ₂ "	
			A4-A5, 8 ¹ / ₂ " × 11"-5 ¹ / ₂ " × 8 ¹ / ₂ "	
2 & 3 holes type	2 holes		A3-A5, 11" × 17"-5 ¹ / ₂ " × 8 ¹ / ₂ "	
			A4-A5, 8 ¹ / ₂ " × 11"-5 ¹ / ₂ " × 8 ¹ / ₂ "	
	3 holes		A3, B4, 11" × 17"	
			A4, B5, 8 ¹ / ₂ " × 11"	

- Since punch holes are made in each copy, the punch hole positions vary slightly.
- The punch hole positions change according to the direction of the paper selected.

Reference

If the punch waste box fills up, ⇒ P.200 “[Removing Punch Waste](#)”.

1 Select the Punch position.

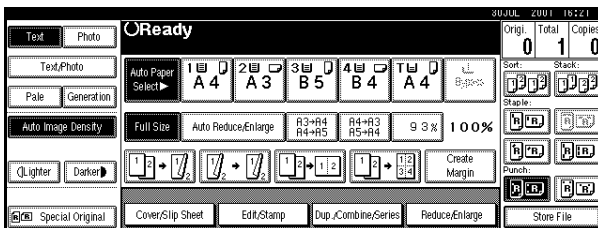

Note

- When stapling copies, also select a stapling position. ⇒ P.47 “[Staple](#)”.

2 Enter the number of copy sets with the number keys.

Note

- To change the entered number, press the **[Clear/Stop]** key.
- If you wish to use the Sort function, press the **[Sort]** key.

3 Set your originals, then press the **[Start]** key.

Copying from the Bypass Tray

Use the bypass tray to copy onto OHP transparencies, adhesive labels, translucent paper, postcards, and copy paper that cannot be set in the paper tray.

Note

- The machine can automatically detect the following sizes as standard size copy paper:

Metric version	A3, A4, A5, 8 1/2" × 13"
Inch version	A3, 11" × 17", 8 1/2" × 14", 8 1/2" × 11", 5 1/2" × 8 1/2"

- If you do not use the standard size copy paper, you should input vertical and horizontal dimensions. The sizes that you can input are as follows:

Metric version	<ul style="list-style-type: none"> • Vertical: 100 – 297mm • Horizontal: 148 – 600mm
Inch version	<ul style="list-style-type: none"> • Vertical: 3.9" – 11.6" • Horizontal: 5.8" – 23.4"

- When using paper larger than 433 mm in size, set it so that it is fed straight into the machine.
- When using paper larger than 433 mm in size, the paper may become wrinkled, and may not be fed into the machine, or may cause paper jams.
- To make copies onto OHP transparencies or thick paper exceeding 128g/m², 35 lb., specify the paper type in ⇒ P.60 "When Copying onto OHP Transparencies or Thick Paper".
- The maximum number of sheets you can set at a time depends on the paper type. For details about paper capacity of the bypass tray, ⇒ P.21 "Copy Paper".

1. Extender

- 1** Open the bypass tray.

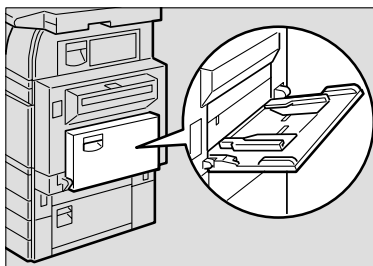

ZDSH110J

- 2** Adjust the guides to copy paper size.

Important

- If the guides are not flush with the copy paper, a skew image or paper misfeeds might occur.

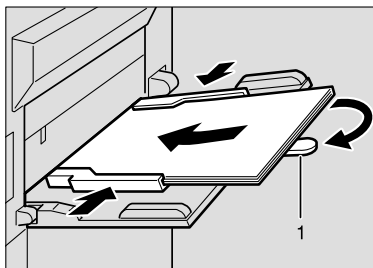

- 3** Lightly insert the copy paper face up until the beeper sounds.

The  indicator on the display automatically goes on.



ZDSH100J









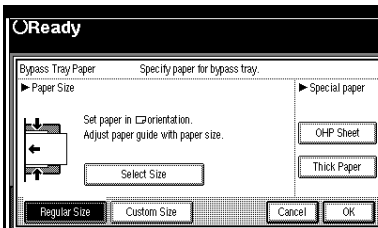
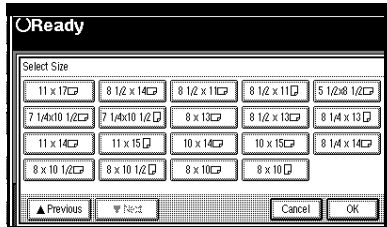
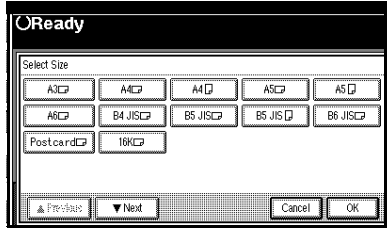













Note

- The face side of the paper set is copied on.
- Do not stack paper over the limit mark, otherwise a skew image or paper misfeeds might occur.
- If the beeper is turned off, lightly insert the copy paper until it stops. Refer to the System Settings manual.
- When the document feeder is open, set the direction of the copy paper to .
- Swing out the extender to support paper sizes larger than A4 , 8¹/₂" × 11" .
- Fan paper to get air between the sheets and avoid a multi-sheet feed.
- Before setting, adjust the paper if curled or warped.

When copying onto standard size paper (Thick Paper, Thin paper, Transparent Paper, or OHP transparencies)

- 1 Press the [#] key.
- 2 Press the [Select Size] key.

**3 Select the paper size.****Note**

- The copy paper sizes that can be selected are as follows:
 - A3 , A4 , A5 ,
 - A6 , B4 , B5 ,
 - B6 , 11×17 , 8¹/₂×14 ,
 - 8¹/₂×11 , 5¹/₂×8¹/₂ ,
 - 7¹/₄×10¹/₂ , 8×13 ,
 - 8¹/₂×13 , 8¹/₄×13 ,
 - 11×14 , 11×15 ,
 - 10×14 , 10×15 ,
 - 8¹/₄×14 , 8×10¹/₂ ,
 - 8×10 

When copying onto custom size paper

Important

- You should specify the size of copy paper to avoid paper misfeeds.

- 1 Press the [#] key.

2 Press the **[Custom Size]** key.

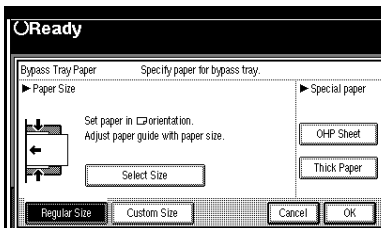

3 Press the **[Vertical mm]** key and enter the vertical size of the paper with the number keys, then press the **[#]** key.

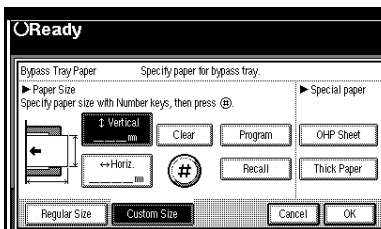

Note

- To change the number entered, press the **[Clear]** or **[Clear/Stop]** key and enter the new number.

4 Enter the horizontal size of the paper with the number keys, then press the **[#]** key.

Note

- If the **[Horiz mm]** key is not highlighted, press the **[Horiz mm]** key.
- To change the number entered, press the **[Clear]** or **[Clear/Stop]** key and enter the new number.

5 To register the custom size entered, press the **[Store]** key and then press the **[Cancel]** key.

Note

- If you do not register the custom size, go to step **6**.
- Only one custom size can be stored.
- To recall the custom size stored, press the **[Recall]** key.
- If you do not register the custom size, the size you set is deleted when modes are cleared.

6 Press the **[OK]** key.

4 Set your originals, then press the **[Start]** key.

5 When your copy job is finished, press the **[Clear Modes]** key to clear the settings.

When Copying onto OHP Transparencies or Thick Paper

To make copies onto OHP transparencies or thick paper, you need to specify the paper type.

Note

- Select **[Thick Paper]** if the paper weight is more than 128g/m², 34 lb.

1 Open the bypass tray, and adjust the guides to the paper size.

Important

- If the guides are not flush with the copy paper, a skew image or paper misfeeds might occur.

- 2** Lightly insert the OHP transparencies or thick paper face down until the beeper sounds.

The  indicator on the display automatically goes on.

 **Important**

- When you set an OHP transparency, make sure that its front and back faces are properly positioned.
- To avoid paper misfeeds, fan the paper before setting it in the tray.

- 3** Press the **【#】** key.

- 4** Select **[OHP Sheet]** or **[Thick Paper]**.

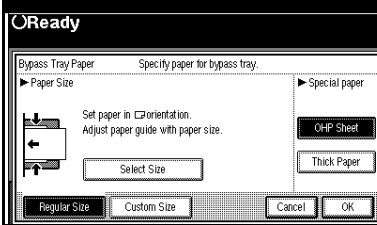

- 5** Press the **[OK]** key.

- 6** Set your originals and press the **【Start】** key.

 **Important**

- When copying onto OHP transparencies, remove copied sheets one by one.

- 7** When your copy job is finished, press the **【Clear Modes】** key to clear the settings.

Programs

You can store frequently used copy job settings in machine memory, and recall them for future use.

❖ Storing Your Settings

You can store your settings you frequently use.

❖ Deleting A Program

You can delete a stored program.

❖ Recalling A Program

You can recall a stored program.

Note

- You can store up to 10 programs.
- You can select the standard mode or program No. 10 as the mode to be set when modes are cleared or reset is made, or immediately after the operation switch is turned on.
- Paper settings are stored based on paper size. So if you place more than one paper tray of the same size, the paper tray prioritized with the User Tools (System Settings) will be selected first. Refer to the System Settings manual.
- Programs are not cleared by turning the power off or by pressing the **[Clear Modes]** key. They are canceled only when you delete or overwrite them with another program.

5 Enter the program name with the

Storing a Program

1 Edit the copy settings so that all functions you want to store in this program are selected.

2 Press the **[Program]** key.

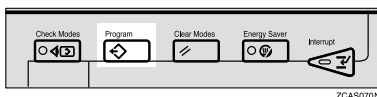

3 Press the **[Register]** key.

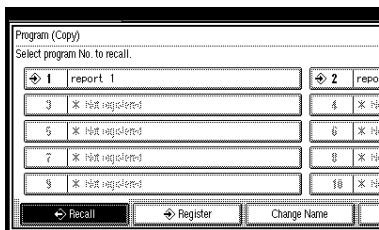

4 Press the program number you want to store.

Note

- Program numbers with  already have settings in them.

Reference

⇒ P.63 “Changing a Stored Program”.

letter keys on the display panel.

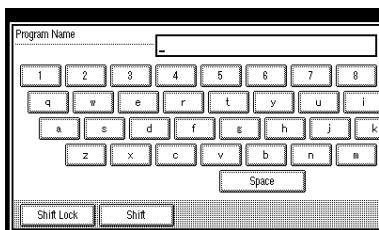

 **Note**

- If you do not wish to enter the program name, go to step **6**.
- You can register up to 40 characters.
- To change the name entered, press the **[Backspace]**, **[Delete]** or **[Clear/Stop]** key and enter new letters.

 **Reference**

For details on entering characters, ⇒ "Entering Text Characters" in the System Settings manual.

6 Press the **[OK]** key.

When the settings are successfully stored, the  indicator goes on.

Changing a Stored Program

1 Make sure the program settings.

 **Note**

- When you want to check the contents of the program, recall the program. ⇒ P.64 "Recalling a Program".

2 Repeat steps **1** to **4** in Storing a Program.

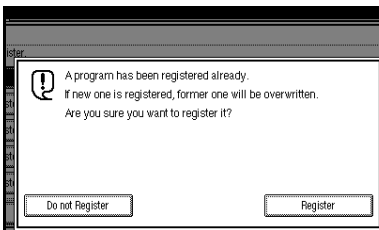

To overwrite the program

 **Important**

- If you select **[Register]**, the previous program is lost.
- 1** Repeat steps **5** and **6** in Storing a Program.

Not to overwrite the program

- 1** Press the **[Do not Register]** key.

Deleting a Program

1 Press the **[Program]** key.



2 Press the **[Delete]** key.

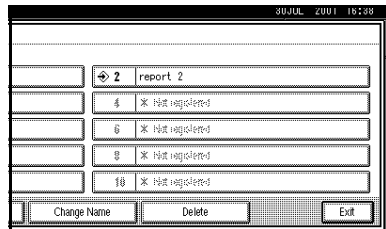

3 Press the program number you want to delete.

4 Press the **[Yes]** key.

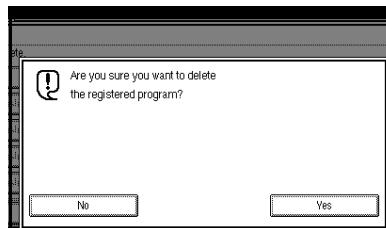

Note

- To cancel the deletion, press the [No] key.

Recalling a Program

- 1 Press the [Program] key.

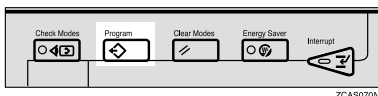

ZCA8070N

- 2 Press the [Recall] key.

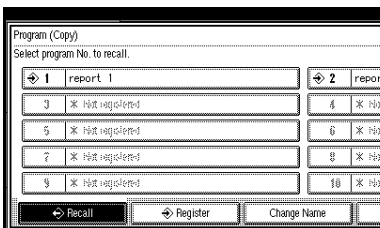

- 3 Press the program number you want to recall.

The stored settings are displayed.

Note

- Only programs with ⇄ contain a program.

- 4 Set your originals, then press the [Start] key.

Job Preset

If a long copy job is in progress and you do not wish to wait for it to finish, you can use this function to set up the next one copy job in advance. When the current copy job is finished, your copy job will be started automatically.

1 Press the [Copy] key.

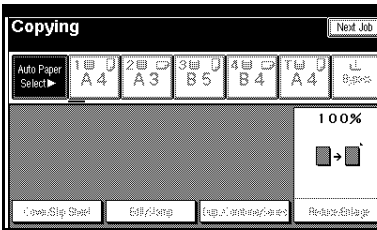

2 Set up the next copy job.

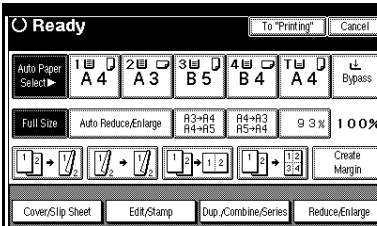

Note

- To cancel this job, press the [Cancel] key.

3 Set the originals in the document feeder and press the [Start] key.

All originals are scanned.

4 Press the [To "Printing"] key.

After the current copy job, the next job starts automatically.

Note

- You can switch the display to the current copy job by pressing the [To "Printing"] key. You can switch the display to the preset job by pressing the [To "Reserving"] key.

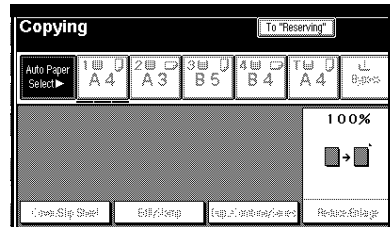

Other Functions

Energy Saver Mode

If you do not operate the machine for a certain period after copying, or when you press the **[Energy Saver]** key, the display disappears and the machine enters Energy Saver mode. When you press the **[Energy Saver]** key again, the machine returns to the ready condition. In Energy Saver mode, the machine uses less electricity.

Note

- If you press the **[Energy Saver]** key during the operation, the current settings will be cleared.
- It takes about 3 seconds to return to the ready condition from Energy Saver mode.

Reference

⇒“Low Power Timer” in the System Settings manual.

Interrupt Copy

Use this function if you wish to interrupt a long copy job to make urgently needed copies.

Limitation

- You cannot use the Interrupt Copy function when scanning fax originals.

Note

- The procedure for making interrupt copies depends on which kind of operation the machine is currently carrying out.

To interrupt an original being fed

- 1** Press the **[Interrupt]** key.

The **Interrupt** indicator goes on and scanning stops.

- 2** Remove the originals that were being copied and set the originals you wish to copy.

- 3** Press the **[Start]** key.

The machine starts making your copies.

- 4** When your copy job is finished, remove your originals and copies.

- 5** Press the **[Interrupt]** key again.

The **Interrupt** indicator goes off.

- 6** When the display prompts you to, replace the originals that were being copied before.

- 7** Press the **[Start]** key.

The previous copy job settings will be restored and the machine will continue copying from where it left off.

To interrupt copying after all originals have been fed

- 1** Press the **[Interrupt]** key.

The **Interrupt** indicator goes on.

Note

- Copying will not stop yet.

- 2** Set your original.

- 3** Press the **[Start]** key.

The machine stops the original job and starts copying your original.

4 When copying is complete, remove your originals and copies.

5 Press the **[Interrupt]** key again.

The **Interrupt** indicator goes off.

The previous copy job settings will be restored and the machine will continue copying from where it left off.

Original Beeper

The beeper sounds and an error message is displayed when you leave your originals on the exposure glass after copying.

Note

- To cancel this function, ⇒ “Tone: Original remains” in P.209 “General Features ²/₄”.

Sample Copy

Use this function to check a copy set before making a long copy run.

Limitation

- This function can be used only when the Sort function has been turned on.

1 Select Sort and any other functions, then enter the number of copy sets to be made.

2 Set the originals.

3 Press the **[Sample Copy]** key.

One copy set is delivered for proof copying.

4 After checking the finish, press the **[Print]** key if the sample is acceptable.

The number of copies made is the number you specified minus one for the proof copy.

Note

- If you press the **[Suspend]** key after checking the finish, return to step **1** to adjust the copy settings as necessary. You can change the settings for Staple, Punch, Duplex, Copy Orientation, Stamp, Margin Adjust, and Cover/Slip Sheet. However, depending on the combinations of functions, some settings might not be changed.
- You cannot use the Sample Copy function after changing the settings.

Changing the Number of Sets

You can change the number of copy sets during copying.

Limitation

- This function can be used only when the Sort function has been turned on.

1 Press the **[Clear/Stop]** key when “Copying” is displayed.

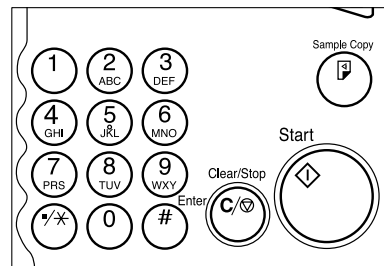

ZCAS060A

2 Press the [Change Quantity] key.

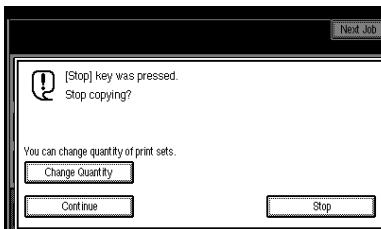

3 Enter the number of copy sets with the number keys, then press the [#] key.

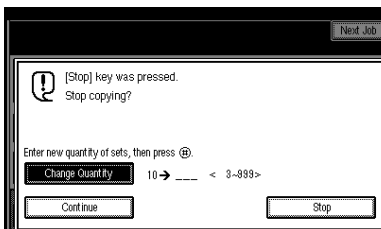

Note

- The number of sets you can enter differs depending on the timing of pressing the [Clear/Stop] key.
- To change the entered number, press the [Clear/Stop] key.

4 Press the [Continue] key.

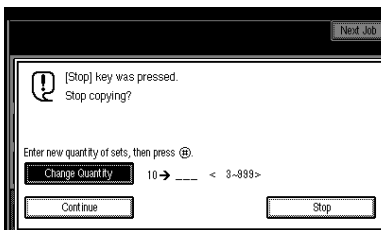

Preset Reduce/Enlarge

You can select a preset ratio for copying.

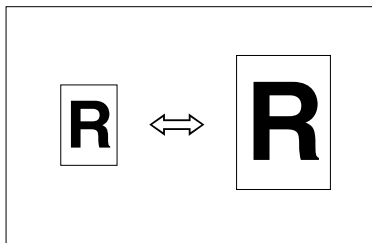

Note

- You can select one of 12 preset ratios (5 enlargement ratios, 7 reduction ratios).
- Use "Create Margin" to reduce the image to 93% of its original size with the centre as reference. You can register this function in a shortcut key on the initial display.
- You can change the preset ratios to other ratios you frequently use. ⇒ "Enlarge" in P.213 "Reproduction Ratio $1/2$ " and "Reduce" in P.214 "Reproduction Ratio $2/2$ ".
- You can set and display three kinds of ratio on the initial display. ⇒ "Shortcut R/E" in P.213 "Reproduction Ratio $1/2$ ".
- You can specify which of [**Reduce**], [**Enlarge**] or [**Mag. Ratio**] is to be given priority and displayed when the [**Reduce/Enlarge**] key is pressed.
- You can select a ratio regardless of the size of an original or copy paper. With some ratios, parts of the image might not be copied or margins will appear on copies.
- Copies can be reduced or enlarged as follows:

◆ Metric version

Ratio (%)	Original → Copy paper size
400 (enlarge area by 16)	--
200 (enlarge area by 4)	A5→A3
141 (enlarge area by 2)	A4→A3, A5→A4
122	F→A3, A4→B4
115	B4→A3
93	--
82	F→A4, B4→A4
75	B4→F4, B4→F
71 (reduce area by $1/2$)	A3→A4, A4→A5
65	A3→F
50 (reduce area by $1/4$)	A3→A5, F→A5
25	--

◆ Inch version

Ratio (%)	Original → Copy paper size
400 (enlarge area by 16)	--
200 (enlarge area by 4)	$5\frac{1}{2}'' \times 8\frac{1}{2}'' \rightarrow 11'' \times 17''$
155 (enlarge area by 2)	$5\frac{1}{2}'' \times 8\frac{1}{2}'' \rightarrow 8\frac{1}{2}'' \times 14''$
129	$8\frac{1}{2}'' \times 11'' \rightarrow 11'' \times 17''$
121	$8\frac{1}{2}'' \times 14'' \rightarrow 11'' \times 17''$
93	--
85	F→ $8\frac{1}{2}'' \times 11''$

Ratio (%)	Original → Copy paper size
78	8 ¹ / ₂ " × 14" → 8 ¹ / ₂ " × 11"
73	11" × 15" → 8 ¹ / ₂ " × 11"
65	11" × 17" → 8 ¹ / ₂ " × 11"
50 (reduce area by 1/4)	11" × 17" → 5 ¹ / ₂ " × 8 ¹ / ₂ "
25	--

1 Press the [Reduce/Enlarge] key.

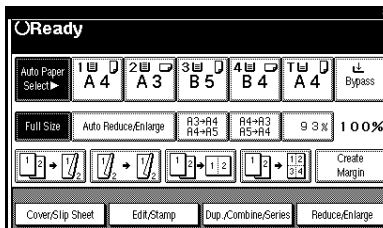

Note

- To select a preset ratio on the initial display, directly press the shortcut reduce/enlarge key and go to step 4.

2 Press the [Enlarge] or [Reduce] key.

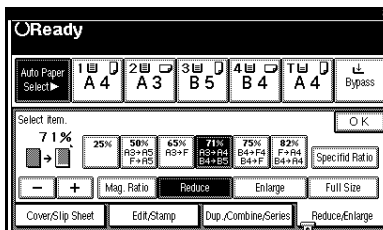

3 Select a ratio.

4 Press the [OK] key.

5 Set your originals, then press the [Start] key.

Create Margin mode

Use "Create Margin" to reduce the image by 93% of its original size with the centre position as reference. You can register this function in a shortcut key on the initial display. By combining it with the Reduce/Enlarge function, you can also provide the Reduce/Enlarge copy with a margin.

Note

- You can register "Create Margin" in a shortcut key.
- You can change the Reduce/Enlarge ratio for "Create Margin".

1 Press the [Create Margin] key displayed on the initial display.

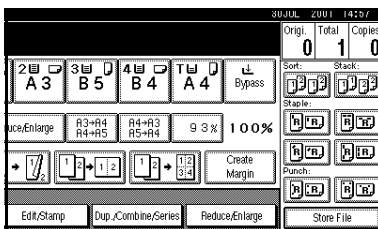

2 If you do not wish to combine it with the Reduce/Enlarge function, set your originals, then press the [Start] key.

Zoom

You can change the reproduction ratio in 1% steps.

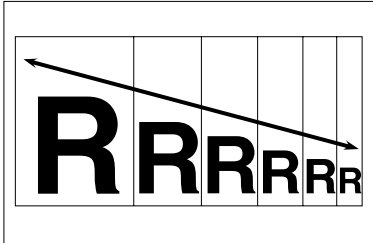

Note

- The following ratios can be selected:
 - Metric version: 25 – 400%
 - Inch version: 25 – 400%
- You can select a ratio regardless of the size of an original or copy paper. With some ratios, parts of the image might not be copied or margins will appear on copies.
- You can select a preset ratio which is near the desired ratio, then adjust the ratio with the **[+]** or **[-]** key.

1 Press the [Reduce/Enlarge] key.

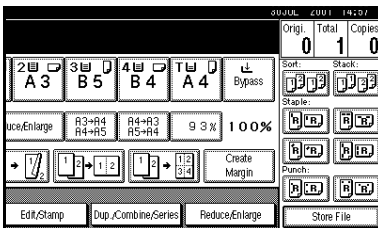

2 Enter the ratio.

To select the ratio with the **[+]** and **[-]** keys

- 1 Select a preset ratio which is close to the desired ratio by using **[Reduce]** or **[Enlarge]**.

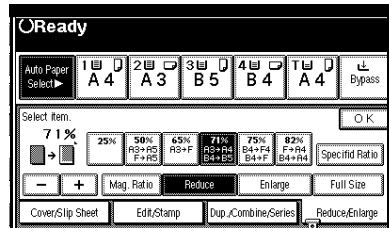

- 2 Adjust the ratios with the **[+]** or **[-]** key.

Note

- To change the ratio in 1% steps, just press the **[+]** or **[-]** key. To change the ratio in 10% steps, press and hold down the **[+]** or **[-]** key.

To enter the ratio with the number keys

- 1 Press the **[Mag. Ratio]** key.

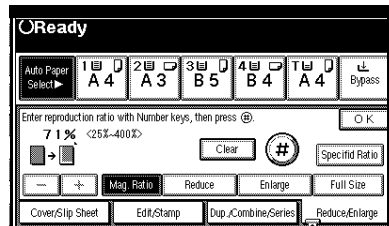

- 2 Enter the desired ratio with the number keys.

 **Note**

- To change the ratio entered, press the **[Clear]** or **[Clear/Stop]** key and enter the new ratio.

- 3 Press the **[#]** key.

- 4 Press the **[OK]** key.

- 3 Set your originals, then press the **[Start]** key.

2

Size Magnification

This function calculates an enlargement or reduction ratio based upon the lengths of the original and copy.

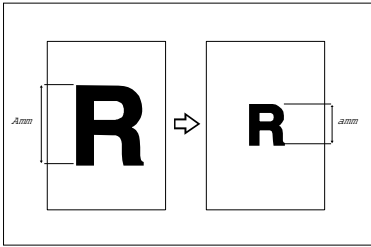

Preparation

Measure and specify the lengths of the original and copy by comparing "A" with "a."

Limitation

- If the calculated ratio is over the maximum or under the minimum ratio, it is corrected within the range of the ratio automatically. However, with some ratios, parts of the image might not be copied or blank margins will appear on copies.

Note

- A ratio is selected in the range of 25 to 400%.

1 Press the [Reduce/Enlarge] key.

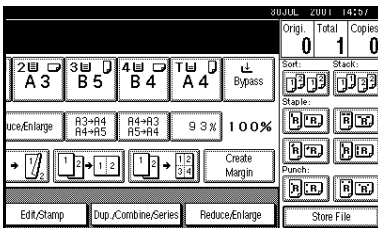

2 Press the [Specifid Ratio] key.

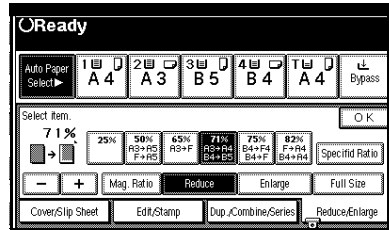

3 Make sure that the [Specifid Ratio] key is highlighted.

4 Enter the length of the original with the number keys and press the [#] key.

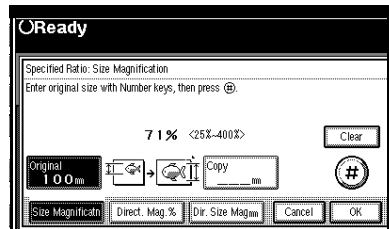

Note

- You can enter sizes within the following ranges:

Metric version	1 – 999mm (in 1mm steps)
Inch version	0.1" – 99.9" (in 0.1" steps)

- To change the length entered, press the [Clear] or [Clear/Stop] key and enter the new length.

2

5 Enter the length of the copy with the number keys and press the [#] key.

 **Note**

- To change the length entered, press the **[Clear]** or **[Clear/Stop]** key and enter the new length.
- To change the length after pressing the [#] key, select **[Original]** or **[Copy]** and enter the desired length.

6 Press the **[OK]** key.

7 Press the **[OK]** key.

8 Set your original, then press the **[Start]** key.

2

Directional Magnification (%)

Copies can be reduced or enlarged at different reproduction ratios horizontally and vertically.

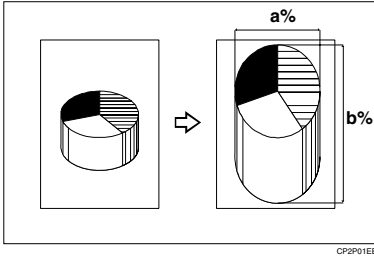

CP2901EE

Note

- The following ratios can be selected:
 - Metric version: 25 – 400%
 - Inch version: 25 – 400%
- You can select a ratio regardless of the size of an original or copy paper. With some ratios, parts of the image might not be copied or blank margins will appear on copies.
- You can also select a preset ratio which is close to the desired ratio by using Reduce or Enlarge, then adjust the ratio with the **[+]** or **[-]** key.

1 Press the [Reduce/Enlarge] key.

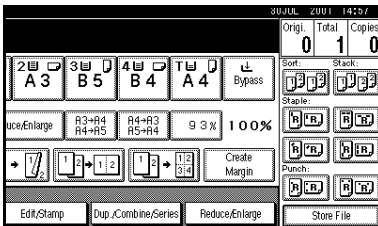

2 Press the [Specifid Ratio] key.

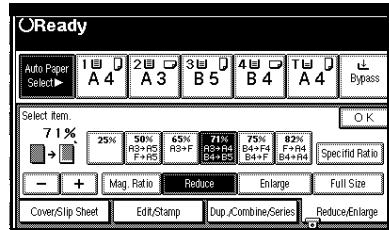

3 Press the [Direct. Mag.%] key.

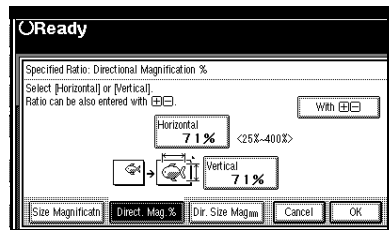

To enter the ratio with the number keys

1 Press the [Horizontal] key.

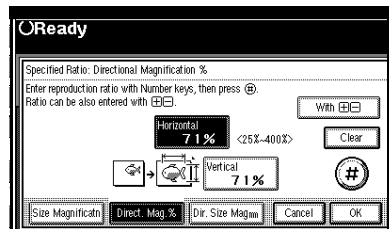

2 Enter the desired ratio with the number keys, followed by the [#] key.

Note

- To change the ratio entered, press the **[Clear]** or **[Clear/Stop]** key and enter the new ratio.

2

- ③ Press the [Vertical] key.
- ④ Enter the desired ratio with the number keys, followed by the [#] key.
- ⑤ Press the [OK] key.

To specify a ratio with the [+] and [-] keys

- ① Press the [With + -] key.
- ② Press the [Horizontal] key.

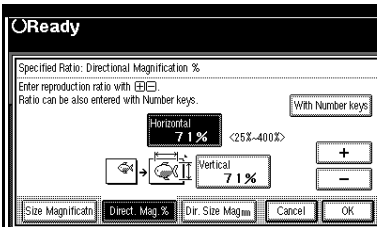

- ③ Adjust the ratio using the [+] or [-] key.

 **Note**

- Pressing the [+] or [-] key changes the ratio in 1% steps. Pressing and holding down the [+] or [-] key changes it in 10% steps.
- If you have incorrectly entered the ratio, readjust the ratio with the [+] or [-] key.

- ④ Press the [Vertical] key.
- ⑤ Adjust the ratio with the [+] or [-] key.
- ⑥ Press the [OK] key.

4 Press the [OK] key.

5 Set your originals, then press the [Start] key.

Directional Size Magnification (mm)

The suitable reproduction ratios will be automatically selected when you enter the horizontal and vertical lengths of the original and copy image you require.

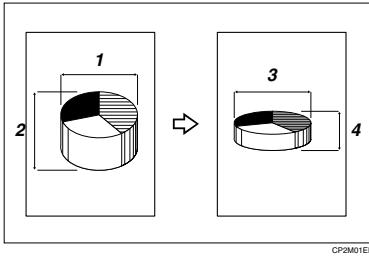

CP2M01EE

- 1: Horizontal original size
- 2: Vertical original size
- 3: Horizontal copy size
- 4: Vertical copy size

Preparation

Specify the vertical and horizontal sizes of the original and those of the copy, as shown in the illustration.

Limitation

- If the calculated ratio is over the maximum or under the minimum ratio, it is corrected within the range of the ratio automatically. However, with some ratios, parts of the image might not be copied or blank margins will appear on copies.

Note

- You can enter sizes within the following ranges:

Metric version	1 – 999mm (in 1mm steps)
Inch version	0.1" – 99.9" (in 0.1" steps)

- The following ratios can be selected:
 - Metric version: 25 – 400%
 - Inch version: 25 – 400%

1 Press the [Reduce/Enlarge] key.

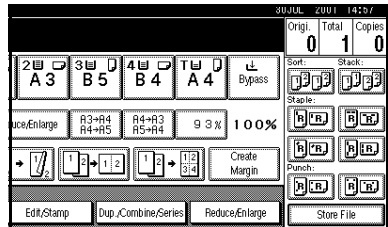

2 Press the [Specific Ratio] key.

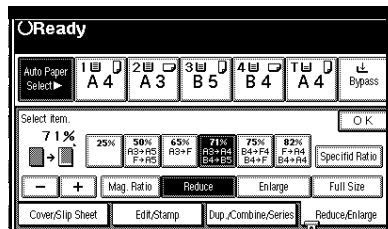

- 3** Press the [Dir.Size Mag mm] key.

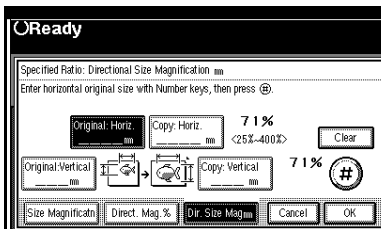

- 4** Enter the horizontal size of the original with the number keys, then press the [#] key.

Note

- To change the value entered, press the [Clear] or [Clear/Stop] key and enter the new value.

- 5** Enter the horizontal size of the copy with the number keys, then press the [#] key.

- 6** Enter the vertical size of the original with the number keys, then press the [#] key.

- 7** Enter the vertical size of the copy with the number keys, then press the [#] key.

Note

- To change the length, press the place you wish to change and enter the new value.

- 8** Press the [OK] key.

- 9** Press the [OK] key.

- 10** Set your originals, then press the [Start] key.

Duplex/Combine/Series

You can make copies in a variety of formats by combining the following modes:

- 1 Sided/2 Sided originals
- 1 Sided/2 Sided copies
- Duplex
- Combine
- Book
- Series

1 Press [Dup./Combine/Series] and check your originals. And select [1 Sided] or [2 Sided] for the originals.

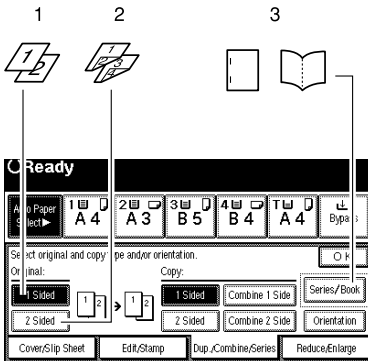

- 1: 1-sided
- 2: 2-sided
- 3: Series/Book

2 Select [1 Sided] or [2 Sided] for copying.

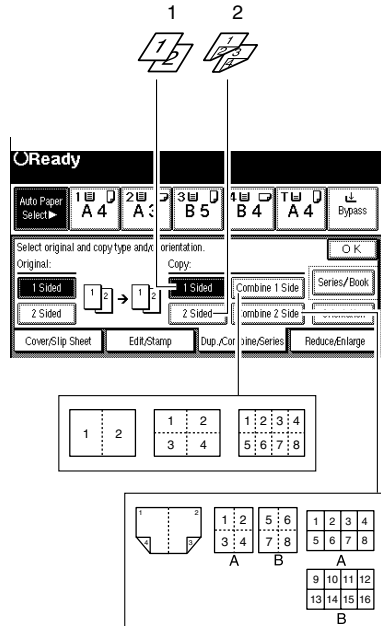

- 1: 1-sided
- 2: 2-sided



- A: Front
- B: Back









3 Press the [OK] key.

ZCAS180E

ZCAS170E

Original Direction and Completed Copies

The resulting copy image will differ according to the direction in which you set your original (lengthwise  or widthwise .

Original	How to Set Your Original	Copy
Vertical	Standard 	Top to Top 
	90° turn 	Top to Bottom 
Horizontal	Standard 	Top to Top 
	90° turn 	Top to Bottom 

GCRYOU1E

Note

- The illustrations show the directions of copied images on the front and back, not the directions of delivery.

Originals and Copy Direction

You can select the orientation ([**Top to Top**], [**Top to Bottom**]). ⇒ P.80 “Specifying Orientation of Bound Originals”.

- Top to Top

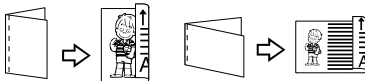

Duplex1

- Top to Bottom

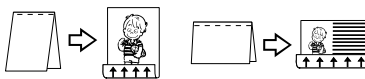

Duplex2

Specifying Orientation of Bound Originals

You can specify the orientation of bound originals (how you turn the pages). The default setting is [**Top to Top**].

Note

- You can change the orientation default with the User Tools. ⇒ “Copy Orientation in Duplex Mode” and “Original Orientation in Duplex Mode” in P.209 “General Features 2/4”.

- Press the [**Dup./Combine/Series**] key.

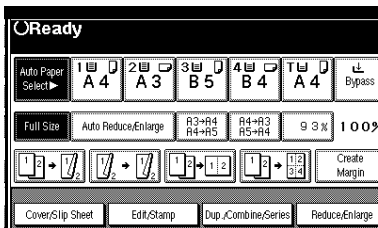

2 Press the [Orientation] key.

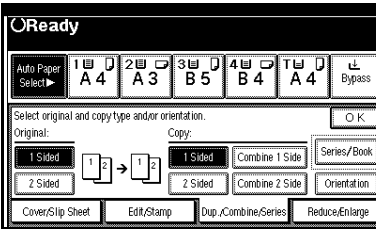

3 Select an original orientation and a copy orientation.

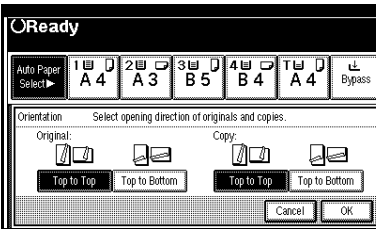

4 Press the [OK] key.

Duplex

This function can be used in two ways:

◆ 1 Sided → 2 Sided

This mode makes two-sided copies from one-sided originals.

◆ 2 Sided → 2 Sided

This mode makes two-sided copies from two-sided originals.

● Limitation

- You cannot use the following copy paper in this function:
 - Paper smaller than A5 \square , $5\frac{1}{2}'' \times 8\frac{1}{2}''$ \square (possible on A5 \square , $5\frac{1}{2}'' \times 8\frac{1}{2}''$ \square)
 - Paper thicker than 105g/m², 28 lb.
 - Paper thinner than 64g/m², 17 lb.
 - Translucent paper
 - Adhesive labels
 - OHP transparencies
 - Postcards
- You cannot use the bypass tray with this function.

1 Sided → 2 Sided

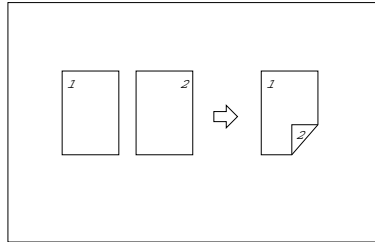

✎ Note

- If you set an odd number of 1-sided originals in the document feeder, the reverse side of the last page is left blank.
- When original images are copied, the images are shifted by a width of the binding margin. You can adjust the binding margin or binding position. You can also change their default values. ⇒ “Front Margin: Left/Right”, “Back Margin: Left/Right”, “Front Margin: Top/Bottom” and “Back Margin: Top/Bottom” in P.216 “Edit 1/2”.
- A binding margin can be automatically made on the back side. ⇒ “1 sided → 2 sided Auto Margin: T to T” in P.216 “Edit 1/2”.

1 Press the [Dup./Combine/Series] key.

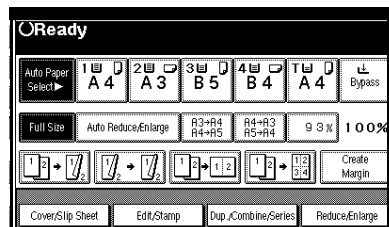

- 2** Press the [1 Sided] key for original, then press the [2 Sided] key for copy.

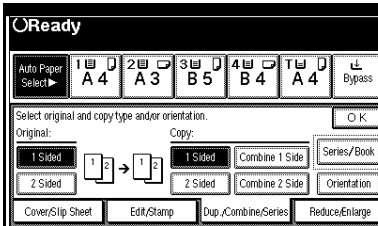

Note

- To change the copy orientation to “Top to Bottom”, press the [Orientation] key and select [Top to Bottom]. ⇒ P.80 “Specifying Orientation of Bound Originals”.

- 3** Press the [OK] key.

- 4** Set your originals, then press the [Start] key.

When setting an original on the exposure glass or in the document feeder using Batch mode

Reference

⇒ P.31 “Batch mode”.

- 1** Set the original, then press the [Start] key.

Note

- Start with the first page to be copied.
- 2** Set the next original. When it is placed on the exposure glass, press the [Start] key.
- 3** Press the [#] key after the last original has been scanned.

- 4** Set your originals, then press the

2 Sided → 2 Sided

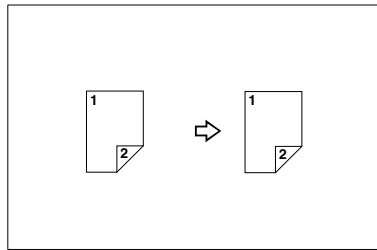

- 1** Press the [Dup./Combine/Series] key.

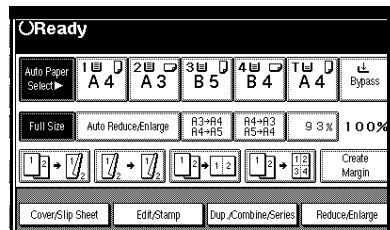

- 2** Press the [2 Sided] key for original, then press the [2 Sided] key for copy.

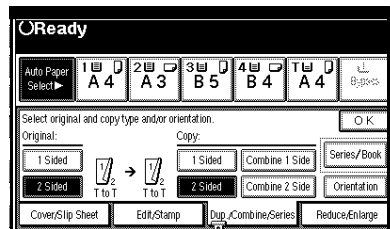

Note

- To change the copy orientation to “Top to Bottom”, press the [Orientation] key and select [Top to Bottom]. ⇒ P.80 “Specifying Orientation of Bound Originals”.

- 3** Press the [OK] key.
[Start] key.

2

When setting an original on the exposure glass or in the document feeder using Batch mode

 **Reference**

⇒ P.31 “Batch mode”.

- 1** Set the original, then press the **【Start】** key.

 **Note**

- Start with the first page to be copied.

- 2** Set the next original. When it is placed on the exposure glass, press the **【Start】** key.
- 3** Press the **【#】** key after the last original has been scanned.

Combine

You can combine two or more originals into one copy. 1 Sided Combine mode is for 1-sided copies, and 2 Sided Combine mode for 2-sided copies. This function can be used in twelve ways:

- ❖ **1 Sided 2 Pages → Combine 1 Side**
Copies two 1-sided originals to one side of a sheet.
- ❖ **1 Sided 4 Pages → Combine 1 Side**
Copies four 1-sided originals together to one side of a sheet.
- ❖ **1 Sided 8 Pages → Combine 1 Side**
Copies eight 1-sided originals together to one side of a sheet.
- ❖ **1 Sided 4 Pages → Combine 2 Side**
Copies four 1-sided originals to the two-page spread on both sides of a sheet.
- ❖ **1 Sided 8 Pages → Combine 2 Side**
Copies eight 1-sided originals together to both sides of a sheet.
- ❖ **1 Sided 16 Pages → Combine 2 Side**
Copies 16 1-sided originals together to both sides of a sheet.
- ❖ **2 Sided 2 Pages → Combine 1 Side**
Copies one 2-sided original to one side of a sheet.
- ❖ **2 Sided 4 Pages → Combine 1 Side**
Copies two 2-sided originals to one side of a sheet.
- ❖ **2 Sided 8 Pages → Combine 1 Side**
Copies four 2-sided originals to one side of a sheet.

- ❖ **2 Sided 4 Pages → Combine 2 Side**
Copies two 2-sided originals together to both sides of a sheet.
- ❖ **2 Sided 8 Pages → Combine 2 Side**
Copies four 2-sided originals together to both sides of a sheet.
- ❖ **2 Sided 16 Pages → Combine 2 Side**
Copies eight 2-sided originals together to both sides of a sheet.

⚠ Limitation

- You cannot use the bypass tray with this function.
- If the calculated ratio is under the minimum ratio, it is corrected within the range of the ratio automatically. However, with some ratios, parts of the image might not be copied.

📝 Note

- In this mode, the machine selects the reproduction ratio automatically. This reproduction ratio depends on the copy paper sizes and the number of originals.
- The machine uses ratios in the following range:
 - Metric version: 25 – 400%
 - Inch version: 25 – 400%
- A separation line between originals can be printed with the User Tools. ⇒ “Separation Line in Combine” in P.218 “Edit $\frac{1}{2}$ ”.
- Even if the direction of originals is different from that of the copy paper, the machine will automatically rotate the image by 90° to make copies properly.

- ❑ When making copies in Combine mode, the border of each original can be automatically erased by 3mm, 0.1". ⇒ "Erase Original Shadow in Combine" in P.216 "Edit 1/2".
- ❑ If the number of originals placed is less than the number specified for combining, the last page is copied blank as shown in the illustration.

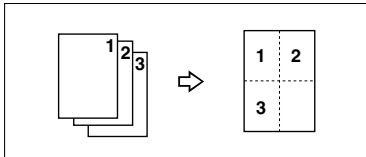

- ❑ You can change the copy order in Combination mode. ⇒ "Copy Order In Combine" in P.218 "Edit 2/2".
- ❑ Direction of the originals and arrangement of combined images.

◆ **Open to Left (L) originals**

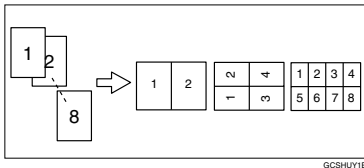

GCSHUY1E

◆ **Open to Right (R) originals**

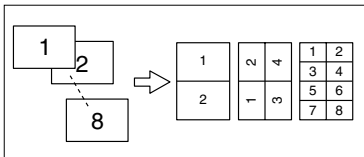

GCSHUY2E

1 Sided 2 Pages → Combine 1 Side

Copies two 1-sided originals to one side of a sheet.

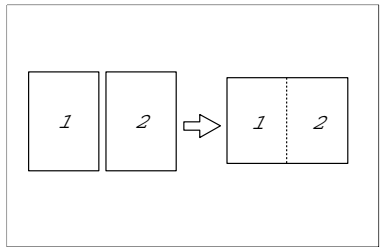

GD-SHW-7J

◆ **Setting originals (Originals set in the document feeder)**

- Originals read from left to right



Combine5

- Originals read from top to bottom

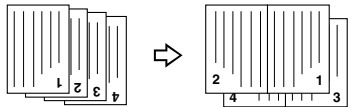

Combine6

- 1** Press the [Dup./Combine/Series] key.

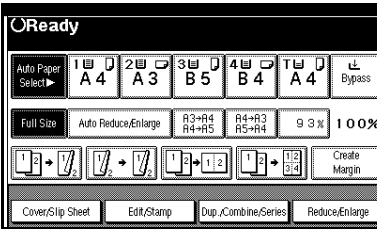

- 2** Press the [1 Sided] key for the original, then press the [Combine 1 Side] key for the copy.

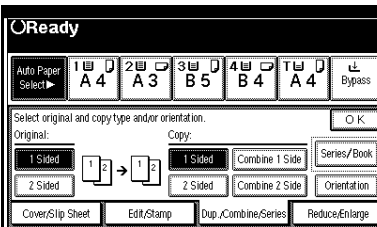

- 3** Press the [2 Originals] key, then press the [OK] key.

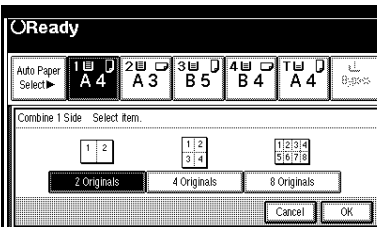

- 4** Select the paper.

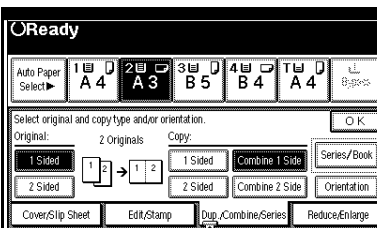

- 5** Set your originals, then press the [Start] key.

1 Sided 4 Pages → Combine 1 Side

Copies four 1-sided originals together to one side of a sheet.

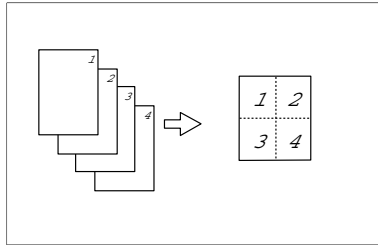

- 1** Press the [Dup./Combine/Series] key.

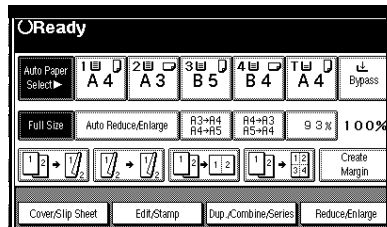

- 2** Press the [1 Sided] key for the original, then press the [Combine 1 Side] key for the copy.

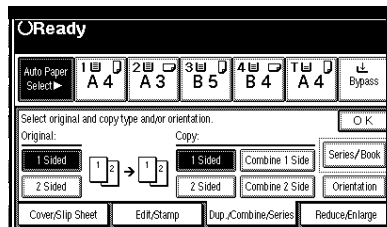

2

- Press the [4 Originals] key, then press the [OK] key.

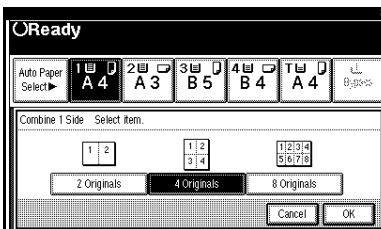

- Select the paper.

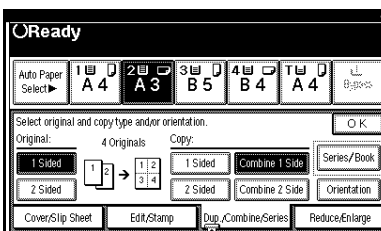

- Set your originals, then press the [Start] key.

1 Sided 8 Pages → Combine 1 Side

Copies eight 1-sided originals together to one side of a sheet.

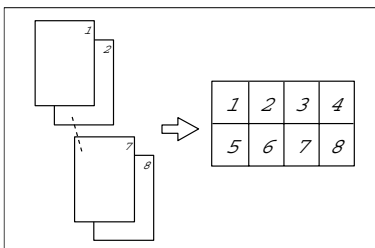

- Press the [Dup./Combine/Series] key.

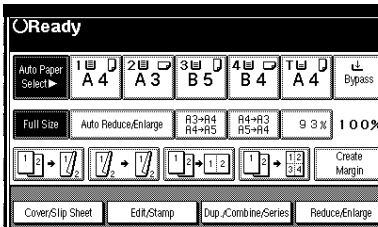

- Press the [1 Sided] key for the original, then press the [Combine 1 Side] key for the copy.

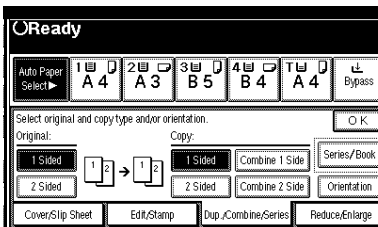

- Press the [8 Originals] key, then press the [OK] key.

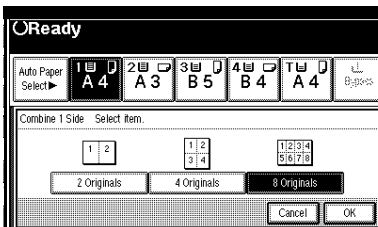

- Select the paper.

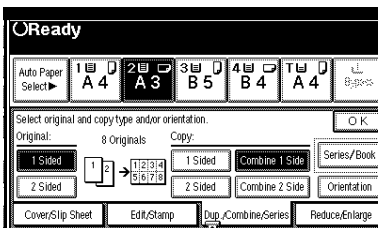

- Set your originals, then press the [Start] key.

1 Sided 4 Pages → Combine 2 Side

Copies four 1-sided originals to the two-page spread on both sides of a sheet.

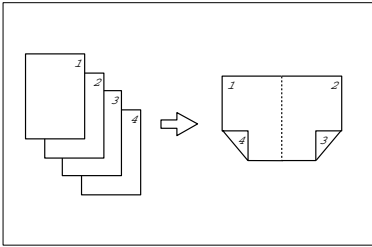

GC 3947A1

1 Press the [Dup./Combine/Series] key.

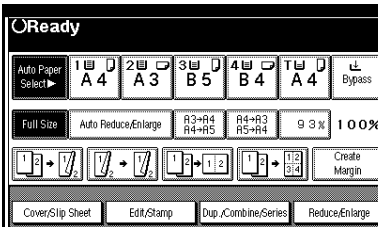

2 Press the [1 Sided] key for the original, then press the [Combine 2 Side] key for the copy.

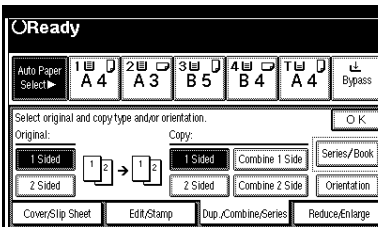

3 Press the [4 Originals] key, then press the [OK] key.

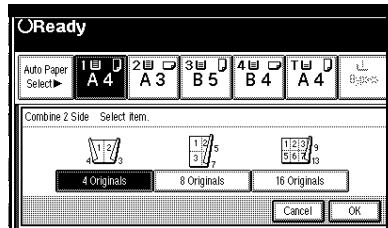

4 Check the orientation.

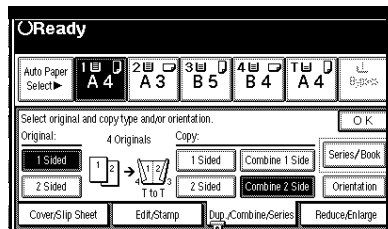

Note

To change the copy orientation to "Top to Bottom", press the [Orientation] key and select [Top to Bottom]. ⇒ P.80 "Specifying Orientation of Bound Originals".

5 Press the [OK] key.

6 Select the paper.

7 Set your originals, then press the [Start] key.

2

1 Sided 8 Pages → Combine 2 Side

Copies eight 1-sided originals together to both sides of a sheet.

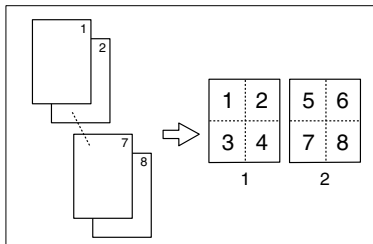

1. Front

2. Back

1 Press the [Dup./Combine/Series] key.

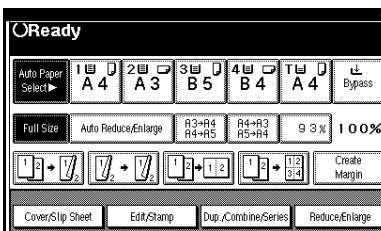

2 Press the [1 Sided] key for the original, then press the [Combine 2 Side] key for the copy.

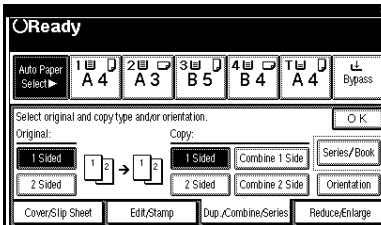

3 Press the [8 Originals] key, then press the [OK] key.

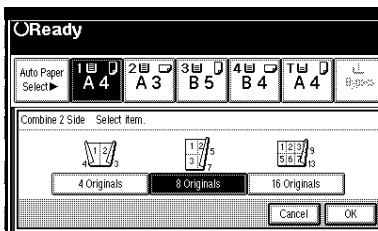

4 Check the orientation.

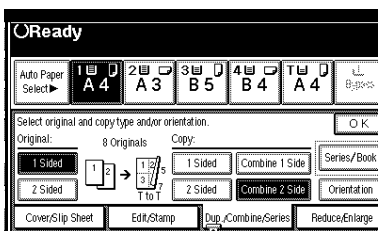

Note

To change the copy orientation to "Top to Bottom", press the [Orientation] key and select [Top to Bottom]. ⇒ P.80 "Specifying Orientation of Bound Originals".

5 Press the [OK] key.

6 Select the paper.

7 Set your originals, then press the [Start] key.

1 Sided 16 Pages → Combine 2 Side

Copies sixteen 1-sided originals together to both sides of a sheet.

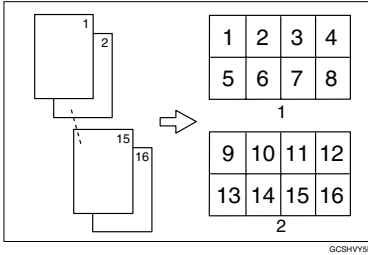

1. Front
2. Back

1 Press the [Dup./Combine/Series] key.

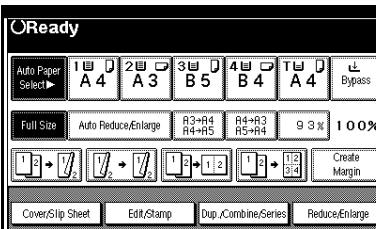

2 Press the [1 Sided] key for the original, then press the [Combine 2 Side] key for the copy.

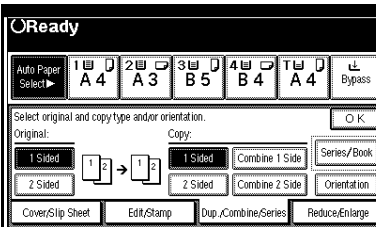

3 Press the [16 Originals] key, then press the [OK] key.

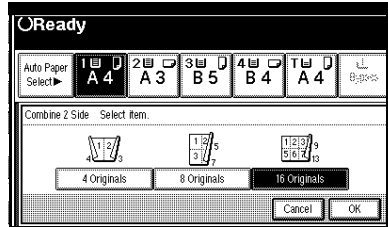

4 Check the orientation.

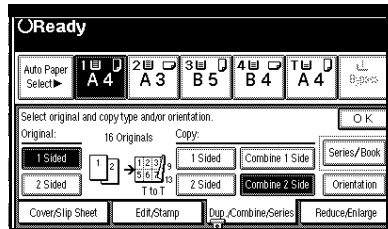

Note

- To change the copy orientation to “Top to Bottom”, press the [Orientation] key and select [Top to Bottom]. See ⇒ P.80 “Specifying Orientation of Bound Originals”.

5 Press the [OK] key.

6 Select the paper.

7 Set your originals, then press the [Start] key.

2

2 Sided 2 Pages → Combine 1 Side

Copies one 2-sided original to one side of a sheet.

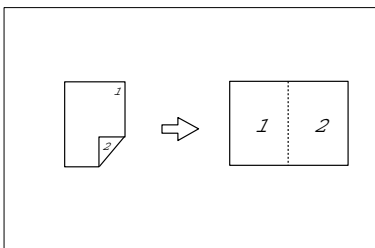

1 Press the [Dup./Combine/Series] key.

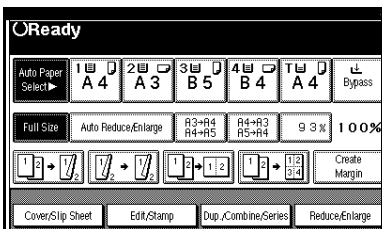

2 Press the [2 Sided] key for the original, then press the [Combine 1 Side] key for the copy.

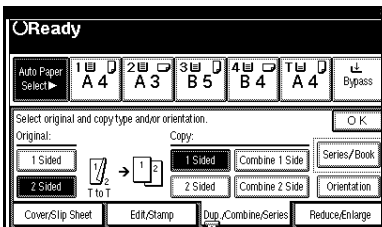

3 Press the [2 Pages] key, then press the [OK] key.

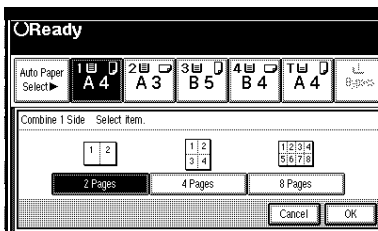

4 Check the orientation.

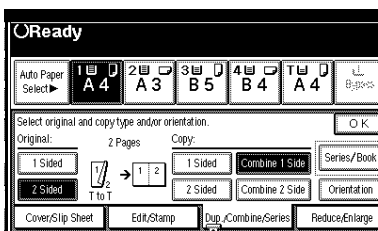

Note

To change the copy orientation to “Top to Bottom”, press the [Orientation] key and select [Top to Bottom]. ⇒ P.80 “Specifying Orientation of Bound Originals”.

5 Press the [OK] key.

6 Select the paper.

7 Set your originals, then press the [Start] key.

2 Sided 4 Pages → Combine 1 Side

Copies two 2-sided originals to one side of a sheet.

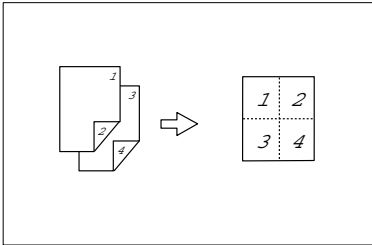

1 Press the [Dup./Combine/Series] key.

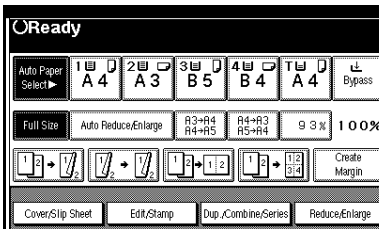

2 Press the [2 Sided] key for the original, then press the [Combine 1 Side] key for the copy.

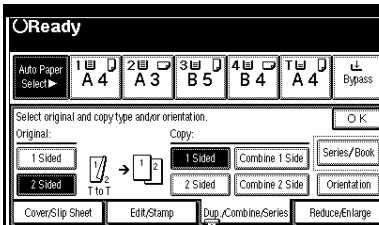

3 Press the [4 Pages] key, then press the [OK] key.

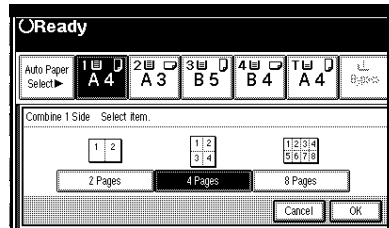

4 Check the orientation.

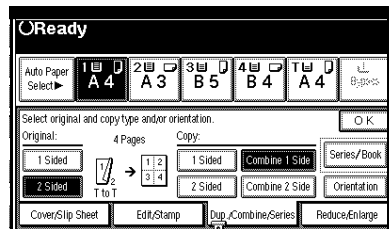

Note

To change the copy orientation to "Top to Bottom", press the [Orientation] key and select [Top to Bottom]. ⇒ P.80 "Specifying Orientation of Bound Originals".

5 Press the [OK] key.

6 Select the paper.

7 Set your originals, then press the [Start] key.

2 Sided 8 Pages → Combine 1 Side

Copies four 2-sided originals to one side of a sheet.

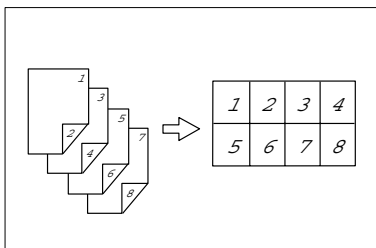

1 Press the [Dup./Combine/Series] key.

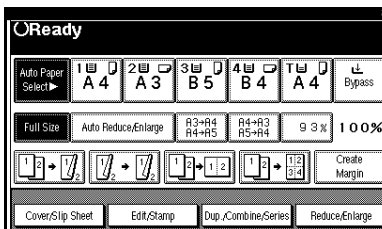

2 Press the [2 Pages] key for the original, then press the [Combine 1 Side] key for the copy.

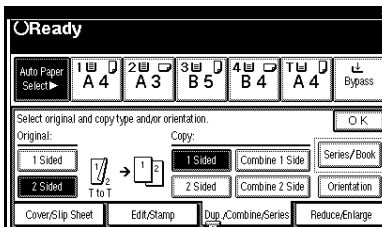

3 Press the [8 Pages] key, then press the [OK] key.

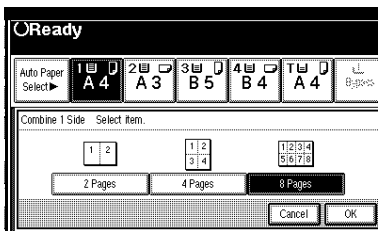

4 Check the orientation.

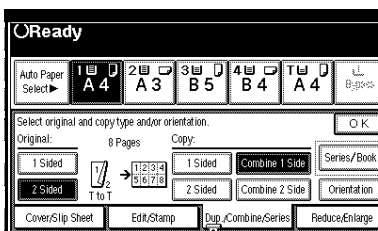

Note

To change the copy orientation to "Top to Bottom", press the [Orientation] key and select [Top to Bottom]. ⇒ P.80 "Specifying Orientation of Bound Originals".

5 Press the [OK] key.

6 Select the paper.

7 Set your originals, then press the [Start] key.

2 Sided 4 Pages → Combine 2 Side

Copies two 2-sided originals together to both sides of a sheet.

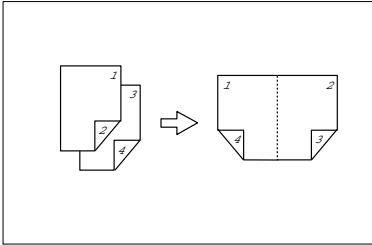

1 Press the [Dup./Combine/Series] key.

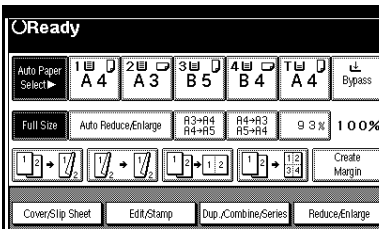

2 Press the [2 Sided] key for the original, then press the [Combine 2 Side] key for the copy.

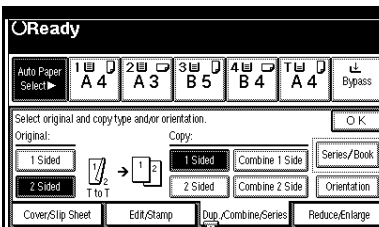

3 Press the [4 Pages] key, then press the [OK] key.

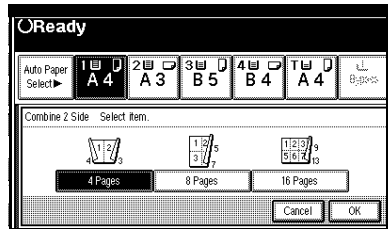

4 Check the orientation.

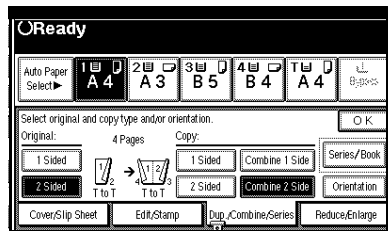

Note

To change the copy orientation to "Top to Bottom", press the [Orientation] key and select [Top to Bottom]. ⇒ P.80 "Specifying Orientation of Bound Originals".

5 Press the [OK] key

6 Select the paper.

7 Set your originals, then press the [Start] key.

2

2 Sided 8 Pages → Combine 2 Side

Copies four 2-sided originals together to both sides of a sheet.

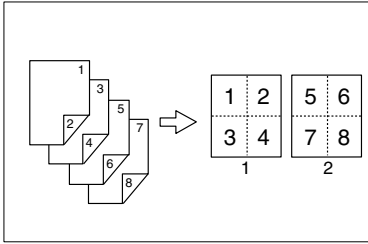

GCSHY2E

1. Front
2. Back

1 Press the [Dup./Combine/Series] key.

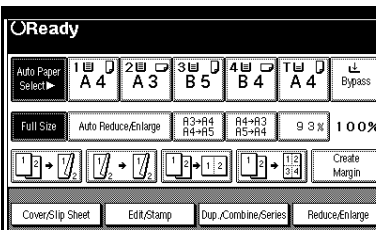

2 Press the [2 Sided] key for the original, then press the [Combine 2 Side] key for the copy.

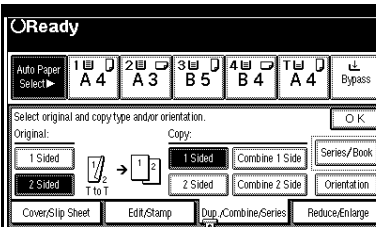

3 Press the [8 Pages] key, then press the [OK] key.

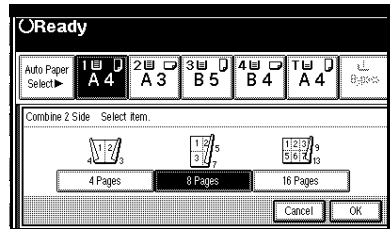

4 Check the orientation.

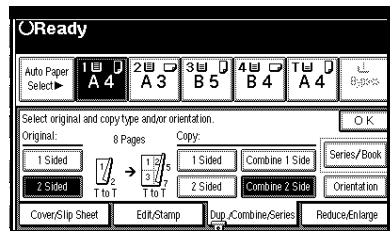

Note

- To change the copy orientation to "Top to Bottom", press the [Orientation] key and select [Top to Bottom]. ⇒ P.80 "Specifying Orientation of Bound Originals".

5 Press the [OK] key

6 Select the paper.

7 Set your originals, then press the [Start] key.

2 Sided 16 Pages → Combine 2 Side

Copies eight 2-sided originals together to both sides of a sheet.

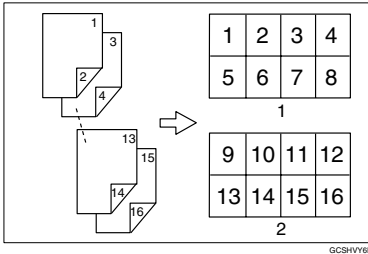

1. Front
2. Back

1 Press the [Dup./Combine/Series] key.

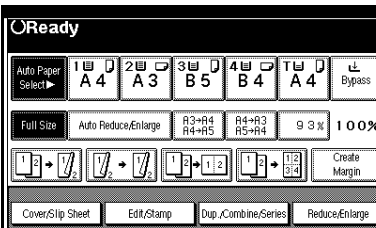

2 Press the [2 Sided] key for the original, then press the [Combine 2 Side] key for the copy.

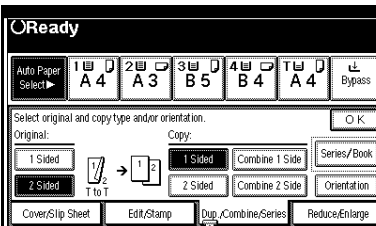

3 Press the [16 Pages] key, then press the [OK] key.

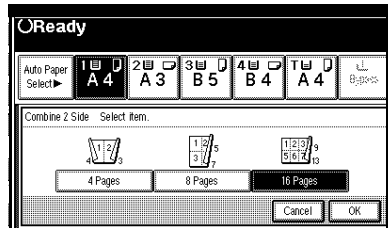

4 Check the orientation.

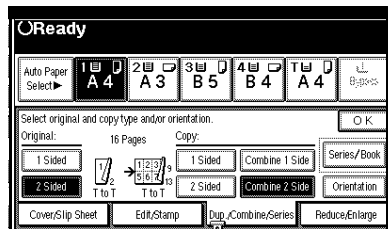

Note

- To change the copy orientation to "Top to Bottom", press the [Orientation] key and select [Top to Bottom]. ⇒ P.80 "Specifying Orientation of Bound Originals".

5 Press the [OK] key.

6 Select the paper.

7 Set your originals, then press the [Start] key.

2

Series/Book

Series copies are made by separately copying the front and back of a 2-sided original or the two facing pages of a spread original onto two sheets of paper. A book is made by copying two or more originals in page order.

The following types of Series and Book modes can be used:

◆ Series Copies

- **Book → 1 Sided**
Copies the two facing pages of a spread original to make two 1-sided copies.
- **Book → 2 Sided**
Copies a spread two-page original onto both sides of a sheet.
- **Front & Back → 2 Sided**
Copies each two-page spread original as it is onto both sides of a sheet.

◆ Booklet

- **1 Sided → Booklet**
Make copies in page order for a folded booklet.
- **2 Sided → Booklet**
Copies a 2-sided original in page order for a folded booklet.
- **1 Sided → Magazine**
Copies two or more originals to make copies in page order (as when they are folded and stacked).
- **2 Sided → Magazine**
Copies 2-sided originals to make copies in page order (as when they are folded and stacked).

Series Copies

Book → 1 Sided

You can make one-sided copies from two facing pages of a bound original (book).

⚠ Limitation

- ❑ You cannot use the Book → 1 Sided function from the document feeder.

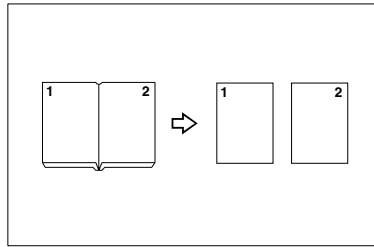

✎ Note

- ❑ See the following table when you select original and copy paper sizes with 100% ratio:

◆ Metric version

Original	Copy paper
A3	A4 × 2 sheets
B4	B5 × 2 sheets
A4	A5 × 2 sheets

◆ Inch version

Original	Copy paper
11" × 17"	8 1/2" × 11" × 2 sheets
8 1/2" × 11"	5 1/2" × 8 1/2" × 2 sheets

1 Press the [Dup./Combine/Series] key.

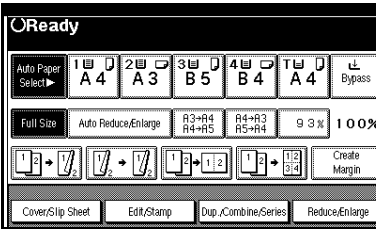

2 Press the [Series/Book] key.

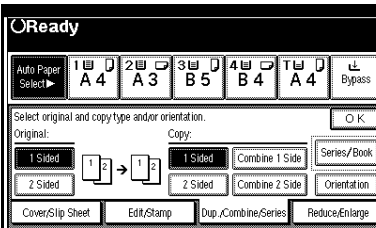

3 Make sure that the [Series] key is selected.

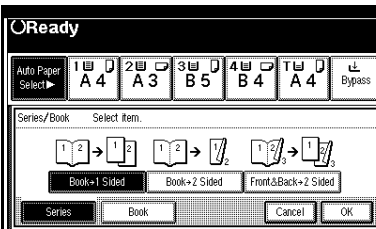

4 Press the [Book→1 Sided] key, then press the [OK] key.

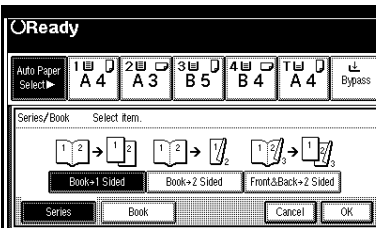

5 Press the [OK] key.

6 Make sure that the [Auto Paper Select] key is selected.

Note

- If the [Auto Paper Select] key is not selected, press the [Auto Paper Select] key.

7 Set your originals, then press the [Start] key.

Book → 2 Sided

Copies a two-page spread original onto both sides of a sheet.

Limitation

- You cannot use the Book → 2 Sided function from the document feeder.

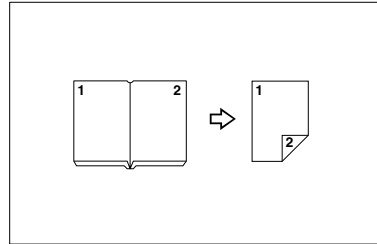

Note

- See the following table when you select original and copy paper sizes with 100% ratio:

◆ Metric version

Original	Copy paper
A3	A4 (2-sided)
B4	B5 (2-sided)
A4	A5 (2-sided)

◆ Inch version

Original	Copy paper
11" × 17"	8 ¹ / ₂ " × 11" (2-sided)
8 ¹ / ₂ " × 11"	5 ¹ / ₂ " × 8 ¹ / ₂ " (2-sided)

2

1 Press the [Dup./Combine/Series] key.

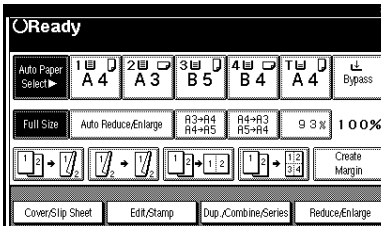

2 Press the [Series/Book] key.

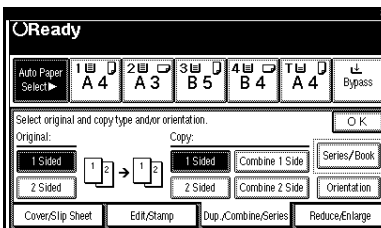

3 Make sure that the [Series] key is selected.

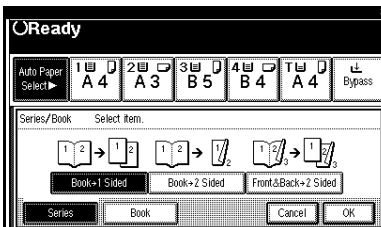

4 Press the [Book→2 Sided] key, then press the [OK] key.

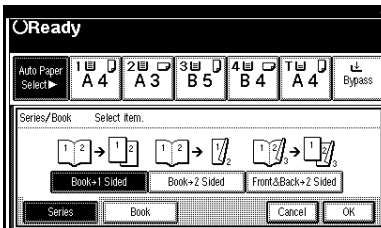

5 Press the [OK] key

6 Select the paper.

7 Set your originals, then press the [Start] key.

Front & Back → 2 Sided

Copies each two-page spread original as it is onto both sides of a sheet.

Limitation

- ❑ You cannot use the Front & Back → 2 Sided function from the document feeder.

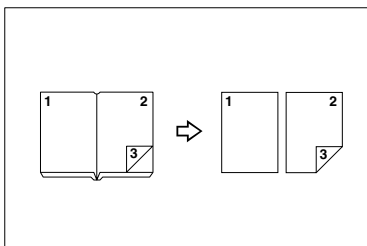

Note

- ❑ See the following table when you select original and copy paper sizes with 100% ratio:

◆ Metric version

Original	Copy paper
A3	A4 (2-sided)
B4	B5 (2-sided)
A4	A5 (2-sided)

◆ Inch version

Original	Copy paper
11" × 17"	8 ¹ / ₂ " × 11" (2-sided)
8 ¹ / ₂ " × 11"	5 ¹ / ₂ " × 8 ¹ / ₂ " (2-sided)

1 Press the [Dup./Combine/Series] key.

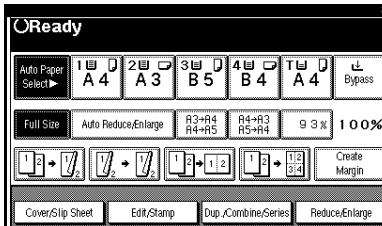

2 Press the [Series/Book] key.

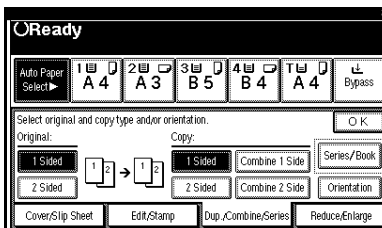

3 Make sure that the [Series] key is selected.

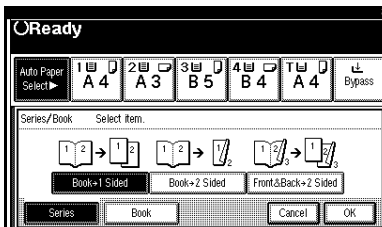

4 Press the [Front & Back → 2 Sided] key, then press the [OK] key.

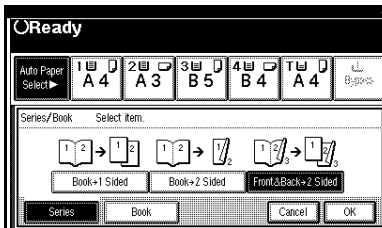

5 Press the [OK] key.

6 Select the paper.

7 Set your originals, then press the [Start] key.

Note

- Press the [#] key after all originals are scanned.

2

Copying Book Originals

Limitation

- You cannot use the bypass tray with this function.

Note

- The machine sets the reproduction ratio automatically to meet the paper size and copies the originals together onto the paper.
- The machine uses ratios in the range of 25 to 400%.
- If the calculated ratio is under the available minimum ratio, it will be adjusted to the minimum ratio. However, with some ratios, parts of the image might not be copied.
- Even if the direction of originals is different from that of the copy paper, the machine will automatically rotate the image by 90° to make copies properly.

1 Sided → Booklet

Make copies in page order for a folded booklet as shown in the following illustrations:

◆ Open to Left

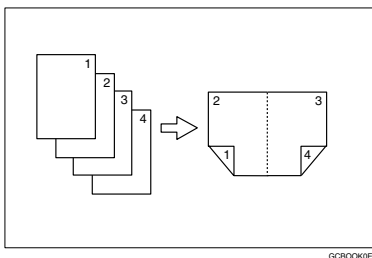

GCBOOKIE

◆ Open to Right

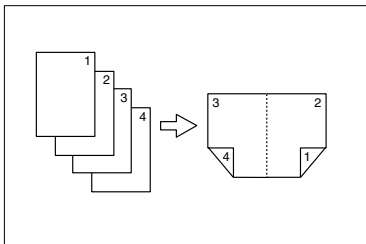

GCBOOKIE

Important

- Before selecting this function, select "Open to left" or "Open to right." with the User Tools. ⇒ "Orientation: Booklet, Margine" in P.218 "Edit 1/2".

Note

- Four originals are copied onto each sheet of copy paper.
- In this mode, the machine sets the reproduction ratio automatically to meet the paper size and copies the originals together onto the paper.
- A ratio is selected in the range of 25 to 400%.
- If the calculated ratio is under the available minimum ratio, it will be adjusted to the minimum ratio. However, with some ratios, parts of the image might not be copied.
- If the number of originals scanned is less than a multiple of 4, the last page is copied blank.
- You can have a 3mm, 0.1" bounding margin around all four edges of the original left blank (erased). ⇒ "Erase Original Shadow in Combine" in P.216 "Edit 1/2".

How to fold copies to make a booklet

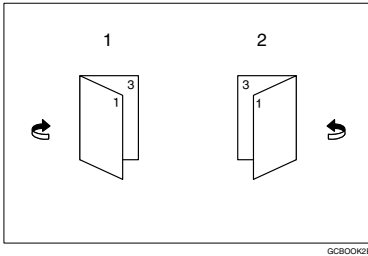

GGBOOK2E

1. Open to Left
2. Open to Right

1 Press the [Dup./Combine/Series] key.

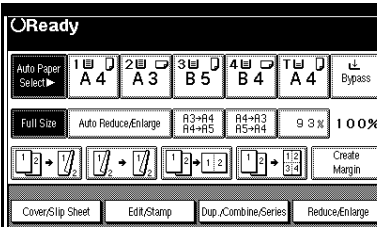

2 Press the [Series/Book] key.

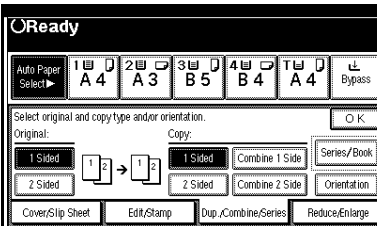

3 Press the [Book] key.

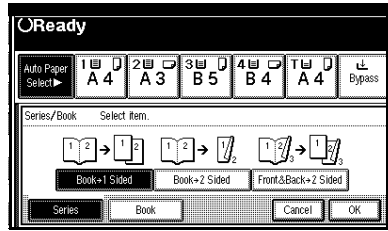

4 Press the [1 Sided → Booklet] key, then press the [OK] key.

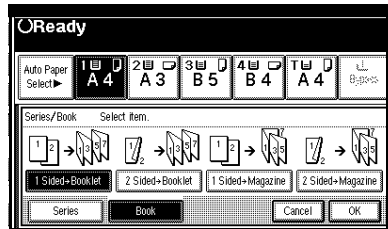

5 Press the [OK] key.

6 Select the paper.

7 Set your originals, then press the [Start] key.

Note

- When placing one original on the exposure glass or in the document feeder in Batch mode, press the [#] key after all originals are scanned.

2

2 Sided → Booklet

Make 2 sided originals to copies in page order for a folded booklet as shown in the following illustrations:

❖ Open to Left

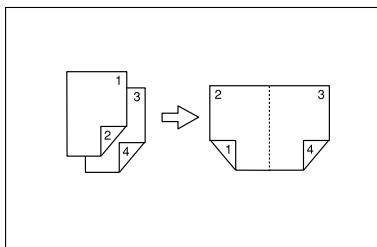

GCAH010E

❖ Open to Right

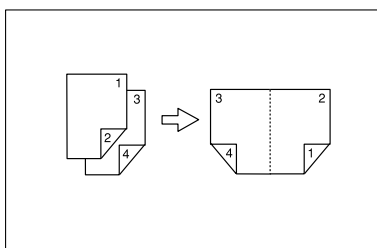

GCAH020E

⚙️ Important

- ❑ Before selecting this function, select “Open to left” or “Open to right.” with the User Tools.
- ❑ Two originals of 2 sided are copied onto each sheet of copy paper.
- ❑ In this mode, the machine sets the reproduction ratio automatically to meet the paper size and copies the originals together onto the paper.
- ❑ A ratio is selected in the range of 25 to 400%.

- ❑ If the calculated ratio is under the available minimum ratio, it will be adjusted to the minimum ratio. However, with some ratios, parts of the image might not be copied.
- ❑ If the number of originals scanned is less than a multiple of 4, the last page is copied blank.
- ❑ You can have a 3mm, 0.1" bounding margin around all four edges of the original left blank (erased).
⇒ “Erase Original Shadow in Combine” in P.216 “Edit 1/2”.

How to fold copies to make a booklet

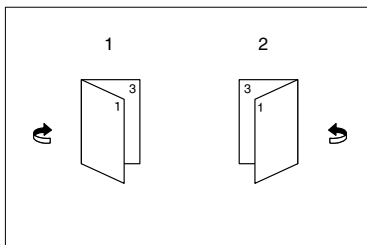

GCBOOKE

1. Open to Left

2. Open to Right

1 Press the [Dup./Combine/Series] key.

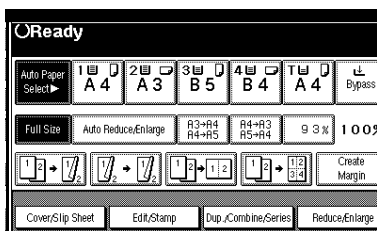

2 Press the [Series/Book] key.

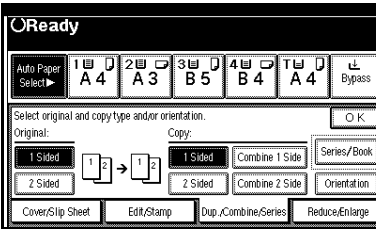

3 Press the [Book] key.

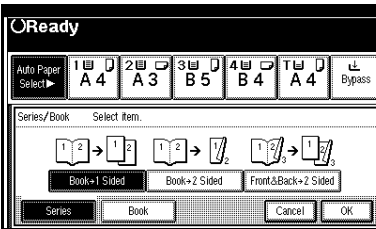

4 Press the [2 Sided → Booklet] key, then press the [OK] key.

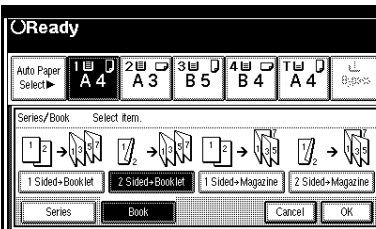

5 Press the [OK] key.

6 Select the paper.

7 Set your originals, then press the [Start] key.

Note

- When placing one original on the exposure glass or in the document feeder in Batch mode, press the [#] key after all originals are scanned.

1 Sided → Magazine

Copies two or more originals to make copies in page order when they are folded and stacked.

◆ Open to Left

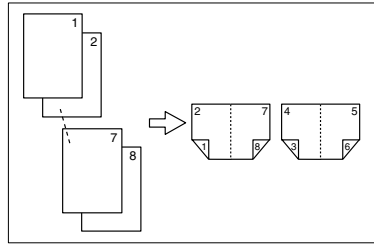

◆ Open to Right

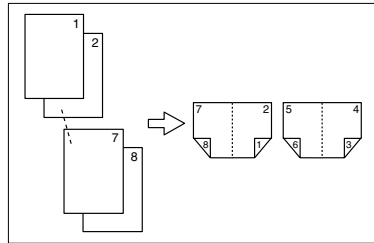

Important

- Before selecting this function, select "Open to left" or "Open to right." with the User Tools. ⇒ "Orientation: Booklet, Magazine" in P.218 "Edit 2/2".

Note

- Four originals are copied onto each sheet of copy paper.
- In this mode, the machine sets the reproduction ratio automatically to meet the paper size and copies the originals together onto the paper.
- A ratio is selected in the range of 25 to 400%.

2

- ❑ If the calculated ratio is under the available minimum ratio, it will be adjusted to the minimum ratio. However, with some ratios, parts of the image might not be copied.
- ❑ If the number of originals scanned is less than a multiple of 4, the last page is copied blank.
- ❑ You can have a 3mm bounding margin around all four edges of the original left blank (erased). ⇒ “Erase Original Shadow in Combine” in P.216 “Edit 1/2”.
- ❑ The copying may take some time after scanning originals.

How to fold and unfold copies to make a magazine

❖ Open to Left

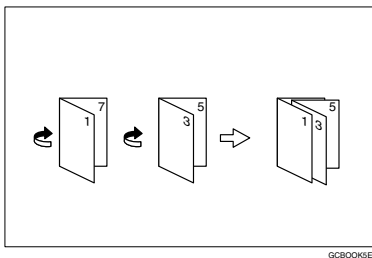

GCBOOK#E

❖ Open to Right

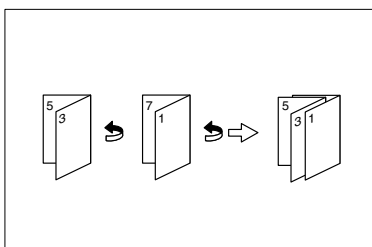

GCBOOK#E

1 Press the [Dup./Combine/Series] key.

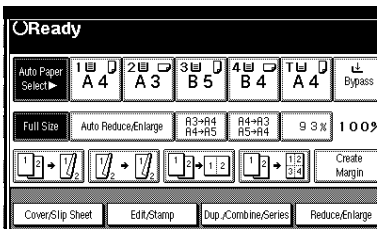

2 Press the [Series/Book] key.

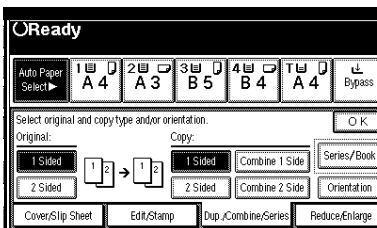

3 Press the [Book] key.

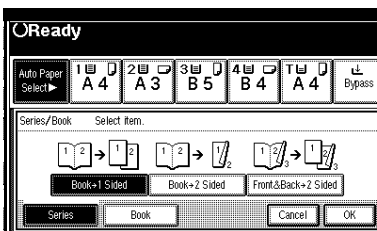

4 Press the [1 Sided → Magazine] key, then press the [OK] key.

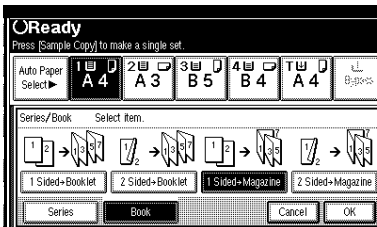

5 Press the [OK] key.

6 Select the paper.

7 Set your originals, then press the **[Start]** key.

Note

- When placing one original on the exposure glass or in the document feeder in Batch mode, press the **[#]** key after all originals are scanned.

2 Sided → Magazine

Copies two or more originals of 2 sided to make copies in page order when they are folded and stacked.

❖ Open to Left

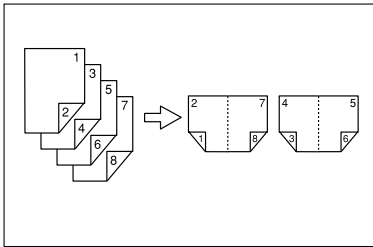

GCAH030E

❖ Open to Right

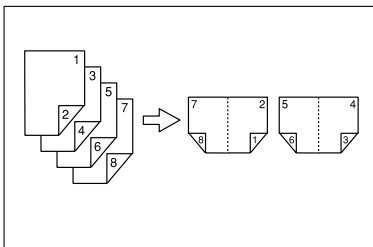

GCAH040E

Important

- Before selecting this function, select "Open to left" or "Open to right." with the User Tools. ⇒ "Orientation: Booklet, Magazine" in P.218 "Edit 1/2".

Note

- Two originals of 2 sided are copied onto each sheet of copy paper.
- Four originals are copied onto each sheet of copy paper.
- In this mode, the machine sets the reproduction ratio automatically to meet the paper size and copies the originals together onto the paper.
- A ratio is selected in the range of 25 to 400%.
- If the calculated ratio is under the available minimum ratio, it will be adjusted to the minimum ratio. However, with some ratios, parts of the image might not be copied.
- If the number of originals scanned is less than a multiple of 4, the last page is copied blank.
- You can have a 3mm bounding margin around all four edges of the original left blank (erased). ⇒ "Erase Original Shadow in Combine" in P.216 "Edit 1/2".
- The copying may take some time after scanning originals.

How to fold and unfold copies to make a magazine

❖ Open to Left

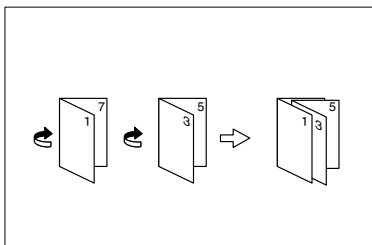

GCBOOKSE

❖ Open to Right

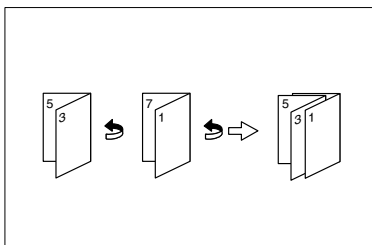

GCBOOKSE

1 Press the [Dup./Combine/Series] key.

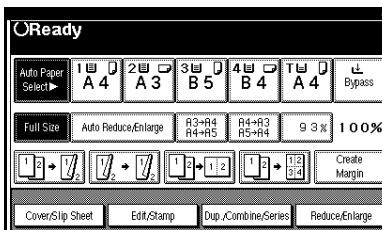

2 Press the [Series/Book] key.

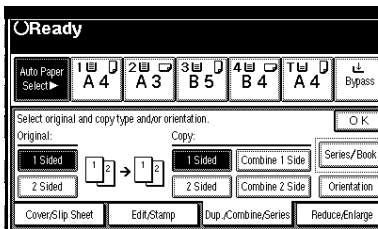

3 Press the [Book] key.

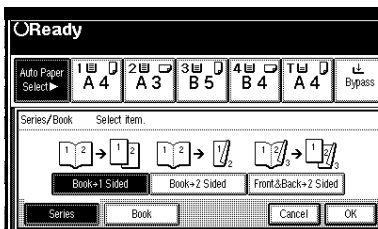

4 Press the [2 Sided → Magazine] key, then press the [OK] key.

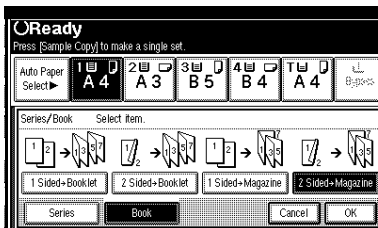

5 Press the [OK] key.

6 Select the paper.

7 Set your originals, then press the [Start] key.

📌 Note

- ❑ When placing one original on the exposure glass or in the document feeder in Batch mode, press the [#] key after all originals are scanned.

Edit Image

Image Repeat

The original image is copied repeatedly.

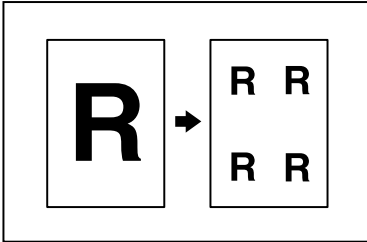

Note

- The number of repeated images depends on the original size, copy paper size, and reproduction ratio. See the following table:

- ❖ Original: A5 /Copy paper: A4
or Original: A5 /Copy paper A4

4 repeats (71%)	16 repeats (35%)
 Repeat1	 Repeat2

- ❖ Original: A5 /Copy paper: A4
or Original: A5 /Copy paper A4

2 repeats (100%)	8 repeats (50%)	32 repeats (25%)
 Repeat3	 Repeat4	 Repeat5

- Part of a repeated image might not be copied depending on copy paper size, copy paper direction or reproduction ratio.
- You can insert separation lines between repeated images. ⇒ “Repeat Separation Line” in P.218 “Edit 2/2”.

- 1** Select the size of the copy paper and the reproduction ratio.
- 2** Press the [Edit/Stamp] key.

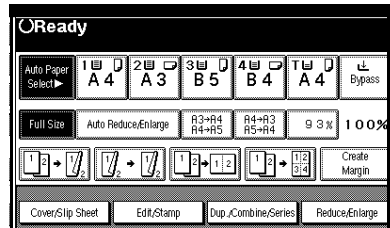

- 3** Press the [Edit Image] key.

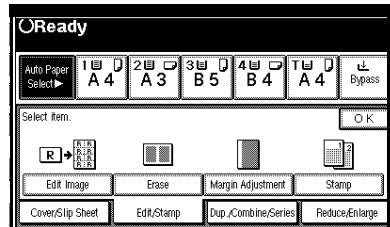

- 4** Press the [Image Repeat] key.

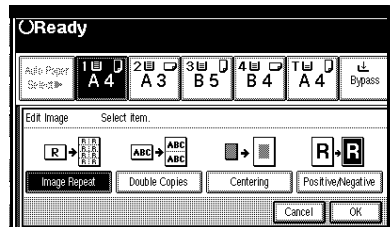

- 5** Press the [OK] key.

- 6 Press the [OK] key.
- 7 Set your original, then press the [Start] key.

Double Copies

One original image is copied twice on one copy as shown in the illustration.

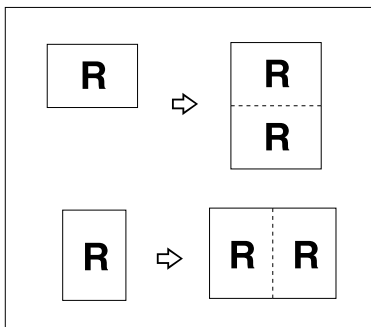

Limitation

- The following originals cannot be detected properly on the exposure glass. Be sure to select the copy paper manually or set the originals in the document feeder.

Metric version	A5, B6
Inch version	5 1/2" x 8 1/2"

- You cannot use the bypass tray with this function.

Note

- You can insert separation lines between repeated images. ⇒ "Double Copies Separation Line" in P.218 "Edit 2/2".

- See the following table when you select original and copy paper sizes with 100% ratio:

◆ Metric version

Original Size and Direction	Copy Paper Size and Direction
A5	A4
B6	B5
A4	A3
A5	A4
B6	B5

◆ Inch version

Original Size and Direction	Copy Paper Size and Direction
5 1/2" x 8 1/2"	8 1/2" x 11"
5 1/2" x 8 1/2"	8 1/2" x 11"
8 1/2" x 11"	11" x 17"

- 1 Press the [Edit/Stamp] key.

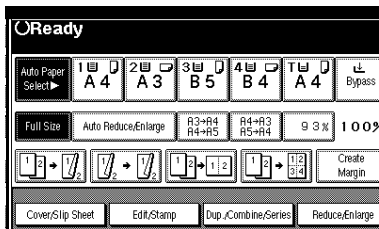

- 2 Press the [Edit Image] key.

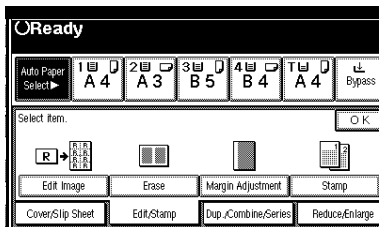

3 Press the [Double Copies] key.

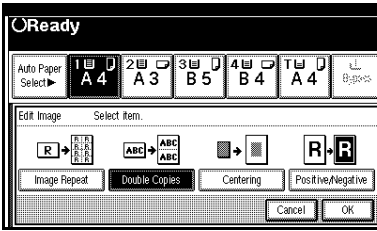

4 Press the [OK] key.

5 Press the [OK] key.

6 Select the paper.

7 Set your originals, then press the [Start] key.

Centering

You can make copies by moving the image to the centre of the copy paper.

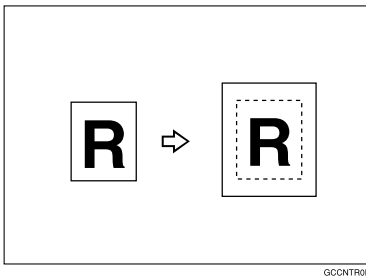

Limitation

- You cannot use the bypass tray with this function.
- If the direction of originals is different from that of the copy paper, the machine will not rotate the image by 90° (rotated copy).
- If the original size cannot be measured, the centring function will not work.

Note

- The original sizes and directions for centring are listed below.

◆ Metric version

Original placed on:	Original size and direction
Exposure glass	A3, B4, A4, B5
Document feeder	A3, B4, A4, B5, A5, B6, 11" × 17"

◆ Inch version

Original placed on:	Original size and direction
Exposure glass	11" × 17", 8 1/2" × 14", 8 1/2" × 11"
Document feeder	A4, 11" × 17", 11" × 15", 8 1/2" × 14", 8 1/2" × 11", 5 1/2" × 8 1/2"

1 Select the paper.

2 Press the [Edit/Stamp] key.

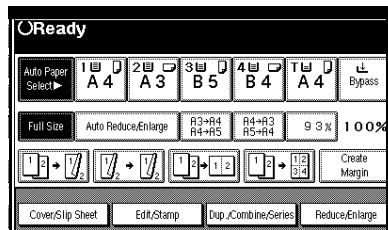

3 Press the [Edit Image] key.

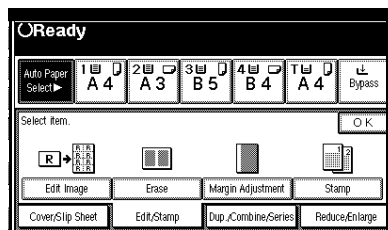

2

4 Press the [Centering] key.

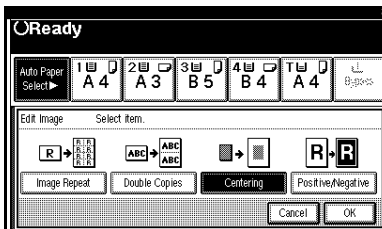

5 Press the [OK] key.

6 Press the [OK] key.

7 Set your originals, then press the [Start] key.

Positive/Negative

If your original is black and white, copy images are inverted.

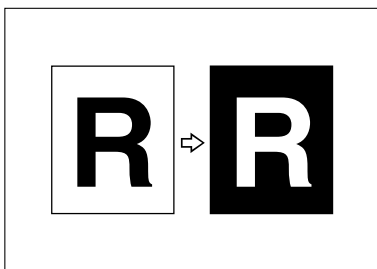

GGHATNVE

1 Press the [Edit/Stamp] key.

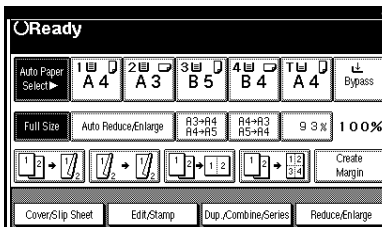

2 Press the [Edit Image] key.

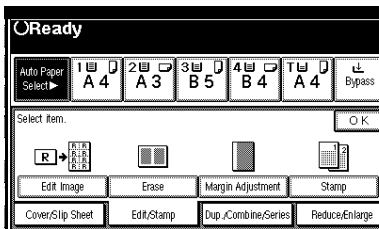

3 Press the [Positive/Negative] key.

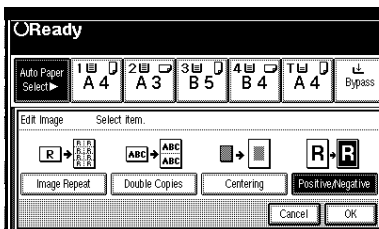

4 Press the [OK] key.

5 Press the [OK] key.

6 Select the paper.

7 Set your originals, then press the [Start] key.

Erase

This function erases the centre and/ or all four sides of the original image. This is useful for avoiding shadows on the copy image caused by the bound originals, such as books.

This function can be used in three ways:

◆ Border

This mode erases the edge margin of the original image.

◆ Center

This mode erases the centre margin of the original image.

◆ Center/Border

This mode erases both the centre and edge margins of the original image.

📎 Note

- ❑ You can change the width of the erased margin as follows:

Metric version	2 – 99mm (in 1mm steps)
Inch version	0.2" – 3.9" (in 0.1" steps)

- ❑ The default setting of the erased margin is as follows. You can change this settings with the User Tools. ⇒ "Erase Border Width" and "Erase Center Width" in P.216 "Edit 1/2".

Metric version	10mm
Inch version	0.4"

- ❑ The width of the erased margin varies depending on the reproduction ratio.

- ❑ If the size of the original is different from sizes listed in the following chart, the erased margin might be shifted.

◆ Metric version

Where Original Is Set	Paper Size and Orientation
Exposure glass	A3☐, B4☐, A4☐☐, B5☐☐
Document feeder	A3☐, B4☐, A4☐☐, B5☐☐, A5☐☐, B6☐☐, 11" × 17"☐

◆ Inch version

Where Original Is Set	Paper Size and Orientation
Exposure glass	11" × 17"☐, 8 1/2" × 14"☐, 8 1/2" × 11"☐☐
Document feeder	A4☐☐, 11" × 17"☐, 8 1/2" × 14"☐, 8 1/2" × 11"☐☐, 5 1/2" × 8 1/2"☐☐

- ❑ The relationship between the original orientation and the erased part is as follows:

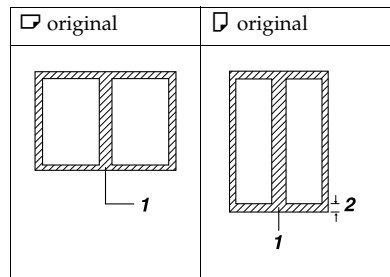

- ❑ 1: Erased part
- ❑ 2: 2–99mm

Border Erase

This function erases the edge margins. You can set the same margin width for all four sides, or you can set different margin widths for each side.

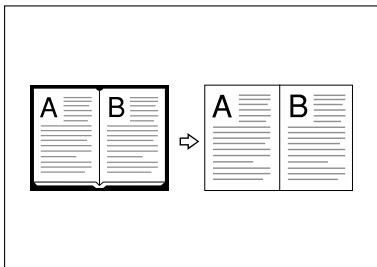

GCCE12E

Note

- If you want to erase the centre margin too, use the Centre/Border function. ⇒ P.116 "Center/Border Erase".

1 Press the [Edit/Stamp] key.

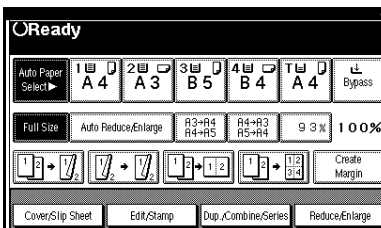

2 Press the [Erase] key.

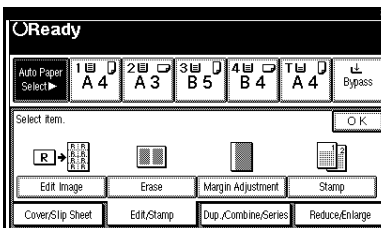

3 Press the [Border] key.

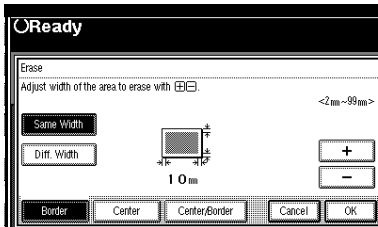

4 Set the erase border width.

Selecting [Same Width]

1 Press the [Same Width] key.

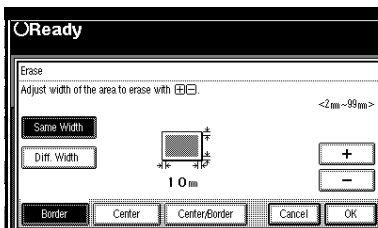

2 Set an erase border width with the [+] and [-] keys, followed by the [OK] key.

Note

- To change the value entered, press the [+] and [-] keys and enter the new value.

Selecting [Diff. Width]

1 Press the [Diff. Width] key.

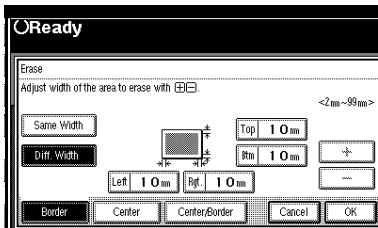

- Press the key for the border you wish to change and set an erase border width with the **[+]** and **[-]** keys.

 **Note**

- To change the value entered, press the **[+]** and **[-]** keys and enter the new value.

- Press the **[OK]** key.

- Press the **[OK]** key.

- Set your originals, then press the **[Start]** key.

Center Erase

This function erases the centre margin.

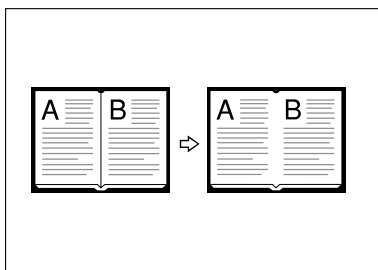

GGCENTIE

 **Note**

- If you want to erase the border margin too, use the Center/Border function. ⇒ P.116 “Center/Border Erase”.

- Press the **[Edit/Stamp]** key.

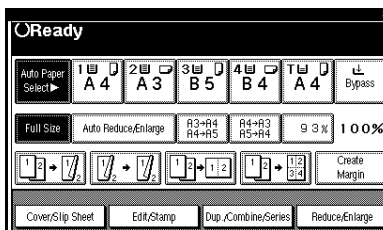

- Press the **[Erase]** key.

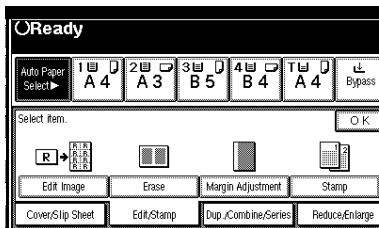

- Press the **[Center]** key.

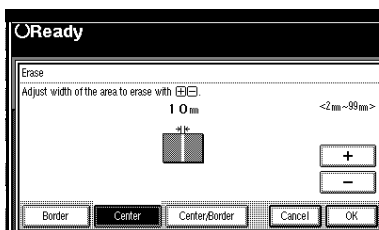

- Set the erase centre width with the **[+]** and **[-]** keys. Then press the **[OK]** key.

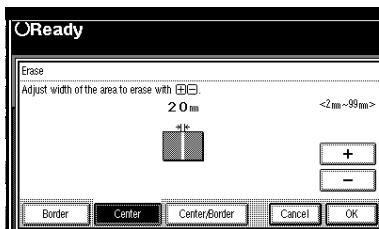

 **Note**

- To change the value entered, press the **[+]** and **[-]** keys and enter the new value.

- Set your originals, then press the **[Start]** key.

2

Center/Border Erase

This mode erases both the centre and edge margins. You can set the same margin width for all four sides and centre, or you can set different margin widths for each.

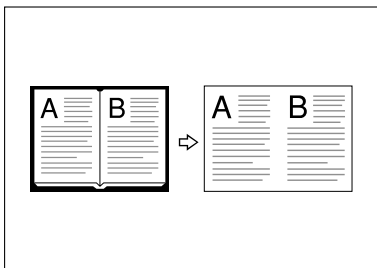

GGCENT3E

1 Press the [Edit/Stamp] key.

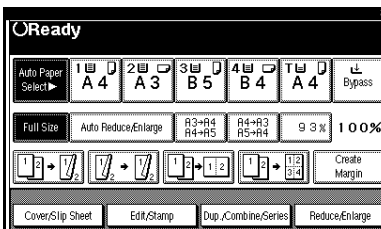

2 Press the [Erase] key.

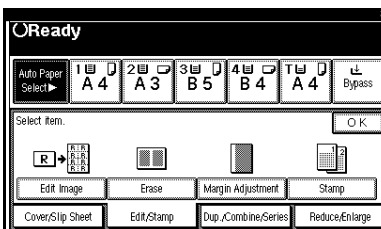

3 Press the [Center/Border] key.

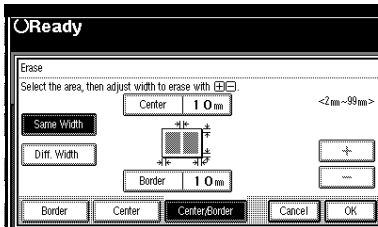

4 Set the erase margin width.

Selecting [Same Width]

1 Press the [Center] key, then set the erase centre width with the [+] and [-] keys.

Note

To change the value entered, press the [+] and [-] keys and enter the new value.

2 Press the [Same Width] key.

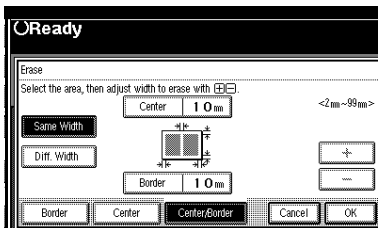

3 Press the [Border] key, then set the erase border width with the [+] and [-] keys.

Note

To change the value entered, press the [+] and [-] keys and enter the new value.

4 Press the [OK] key.

Selecting [Diff. Width]

- 1 Press the [Diff. Width] key.

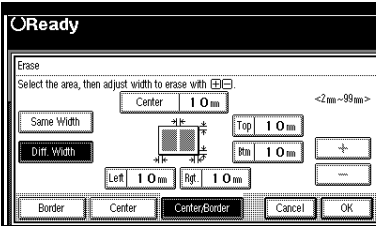

- 2 Press the key for the part you wish to change and set an erase margin width with the [+] and [-] keys.

Note

- To change the value entered, press the [+] and [-] keys and enter the new value.

- 3 Press the [OK] key.

- 5 Press the [OK] key.

- 6 Set your originals, then press the [Start] key.

Margin Adjustment

You can shift the image left, right, top or bottom to make a binding margin.

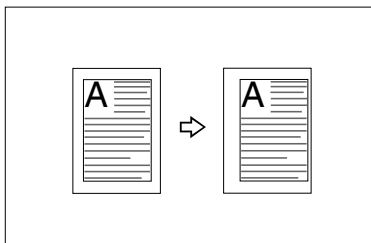

Limitation

- ❑ If you set the margin too wide, areas you do not want to delete might be erased.

Note

- ❑ You can change the width of the binding margin as follows:

Metric version	0 – 30mm (in 1mm steps)
Inch version	0" – 1.2" (in 0.1" steps)

- ❑ The margin width default is as follows. You can change this default setting with the User Tools. ⇒ "Front Margin: Left/Right", "Back Margin: Left/Right", "Front Margin: Top/Bottom", "Back Margin: Top/Bottom" in P.216 "Edit 1/2".

Metric version	<ul style="list-style-type: none"> • Front: 5mm Left • Back: 5mm Right
Inch version	<ul style="list-style-type: none"> • Front: 0.2" Left • Back: 0.2" Right

- ❑ When making two-sided copies from one-sided originals, you can set a binding margin for back pages. ⇒ "1 sided → 2 sided Auto Margin: T to T", "1 sided → 2 sided Auto Margin: T to B" in P.216 "Edit 1/2".
- ❑ When making copies in Combine mode, the binding margins are made on the copies after the combining is finished.
- ❑ When "2 Sided → 1 Sided" is selected, set the binding margins for front and back pages of the original.

1 Press the [Edit/Stamp] key.

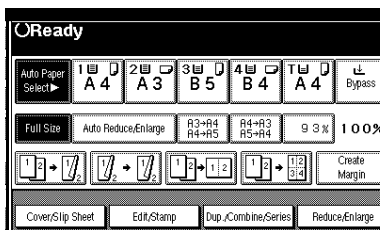

2 Press the [Margin Adjustment] key.

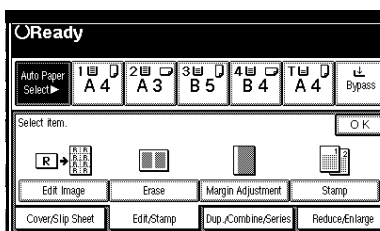

- 3** Set a binding margin for a front page. Press the [←] and [→] keys when setting the left and right margins, and the [↓] and [↑] keys when setting the top and bottom margins.

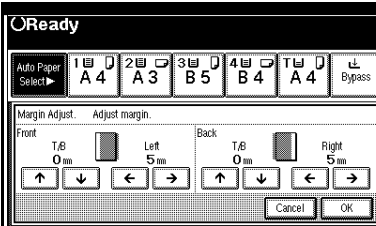

Note

- To change the value entered, press the [←], [→], [↓], [↑] keys and enter the new value.

- 4** Set a binding margin for back pages. Press the [←] and [→] keys when setting the left and right margins, and the [↓] and [↑] keys when setting the top and bottom margins.

Note

- You can specify the back margin only when the Duplex or the Two Sided copy with Combine is selected.
- If you do not need to specify the back margin, press the [OK] key and go to step **5**.

- 5** Press the [OK] key.

- 6** Set your originals, then press the [Start] key.

Stamp

This function prints stamp on the copies. Stamp modes are as follows:

❖ Background Numbering

This function prints numbers on the background of copies.

❖ Preset Stamp

This function prints preset messages on copies.

❖ User Stamp

This function prints custom messages on copies.

❖ Date Stamp

This function prints the date on copies.

❖ Page Numbering

This function prints page numbers on copies.

Background Numbering

32 MB of memory is required to use this function (If the machine is equipped with the Printer unit, 32MB memory is not required.).

Use this function to have numbers printed on the background of copies.

This function can help you to keep track of confidential documents.

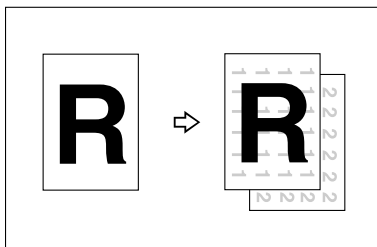

GCSTMP2E

📌 Note

- ❑ You can change the size of the numbers with the User Tools. ⇒ “Size” in P.221 “Background Numbering”.
- ❑ You can change the density of the numbers with the User Tools. ⇒ “Density” in P.221 “Background Numbering”.
- ❑ The numbers appear to overlap the copied image in some cases.

1 Press the [Edit/Stamp] key.

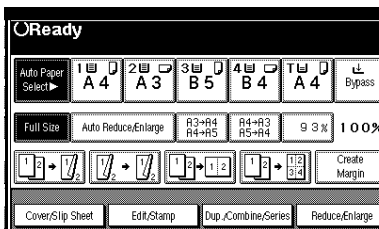

2 Press the [Stamp] key.

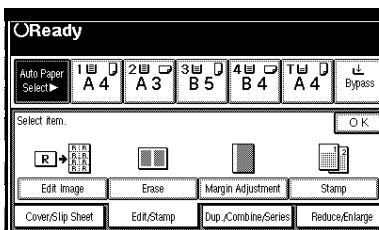

- 3** Press the [Background Numbering] key.

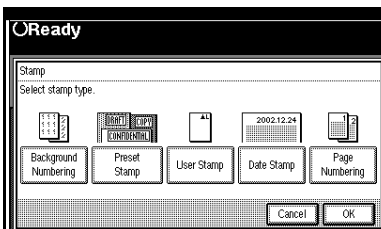

- 4** Enter the number to start counting from with the number keys. Then press the [OK] key.

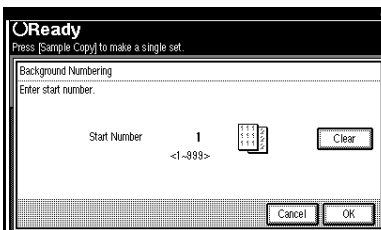

Note

- The number can be set from 1 to 999.
- To change the entered number, press the [Clear] or [Clear/Stop] key and enter the new number.

- 5** Press the [OK] key.

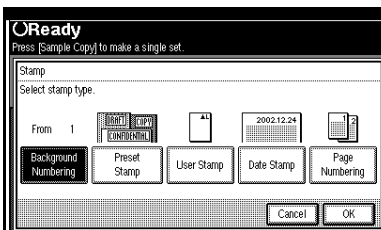

- 6** Press the [OK] key.

- 7** Set your originals, then press the [Start] key.

Preset Stamp

32 MB of memory is required to use this function (If the machine is equipped with the Printer unit, 32 MB memory is not required.).

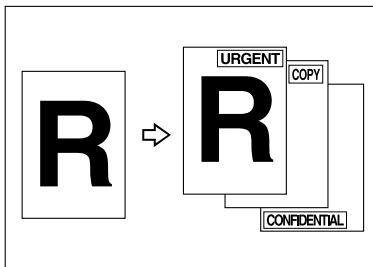

GCSTMP1E

Limitation

- You cannot use the bypass tray with this function.
- One message can be stamped at a time.

Note

- One of the following eight messages can be stamped on copies with a frame around it: "COPY", "URGENT", "PRIORITY", "For Your Info.", "Preliminary", "For internal use", "CONFIDENTIAL", "DRAFT".
- You can change the print page with the User Tools.
- You can change the size and density of the stamp with the User Tools.
- Depending on the paper size, if you change the stamp size, parts of the stamp might not be printed.

- ❑ You can choose the default settings for the position, size and density of the stamp with the User Tools. ⇒ “Stamp Position”, “Stamp Format” in P.221 “Preset Stamp $1/4$ - $4/4$ ”.
- ❑ You can choose the default settings for the print page with the User Tools. ⇒ “Stamp Format” in P.221 “Preset Stamp $1/4$ - $4/4$ ”.
- ❑ You can change the stamp language with the User Tools. ⇒ “Stamp Language” in P.221 “Preset Stamp $1/4$ - $4/4$ ”.
- ❑ The relationship between the direction in which you set the original and stamp orientation/position is as follows:

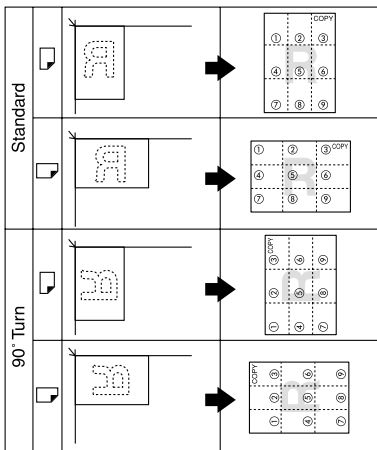

Key on the display

Stamp position	①	②	③	④	⑤	⑥	⑦	⑧	⑨
----------------	---	---	---	---	---	---	---	---	---

GCSTMPSE

- ❑ You can change the stamp position to top, bottom, left and right each way in 1mm, 0.1" steps. ⇒ “Stamp position” in P.221 “Preset Stamp $1/4$ - $4/4$ ”.

1 Press the [Edit/Stamp] key.

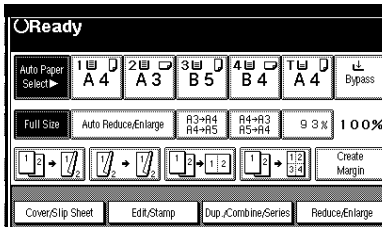

2 Press the [Stamp] key.

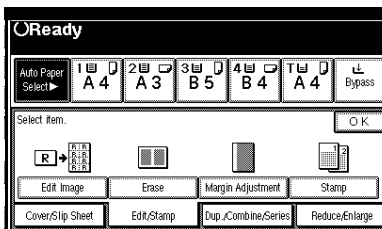

3 Press the [Preset Stamp] key.

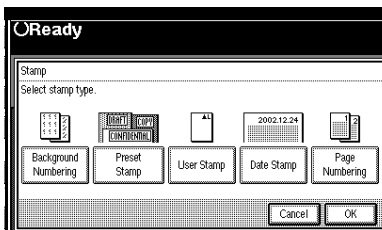

4 Select the desired message.

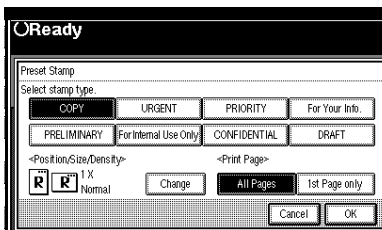

5 Press the [All Pages] or [1st Page only] key to select the print page.

- 6** Change the stamp position, size or density.

If you do not wish to change, go to step **7**.

To change the stamp position, size or density

- 1** Press the [Change] key.
- 2** Select the desired position, size and density.

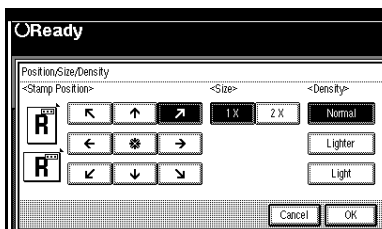

- 3** Press the [OK] key.

- 7** After you specified all the desired settings, press the [OK] key.

- 8** Press the [Cancel] key.

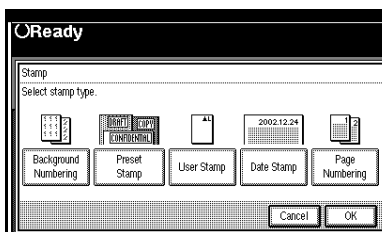

Note

- To cancel the settings, press the [Cancel] key.

- 9** Set your originals, then press the [Start] key.

User Stamp

32 MB of memory is required to use this function (If the machine is equipped with the Printer unit, 32 MB memory is not required.).

Up to four messages which you use frequently can be stored in the machine's memory and stamped on copies.

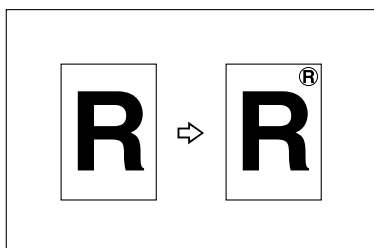

GCSTMP0E

Preparation

Before using this function, you have to store your messages with the User Tools. ⇒ P.125 "Program/Delete User Stamp".

Limitation

- You cannot use the bypass tray with this function.
- One message can be stamped at a time.

Note

- You can change the print page with the User Tools.

- The relationship between the direction in which you set the original and stamp Orientation/Position is as follows:

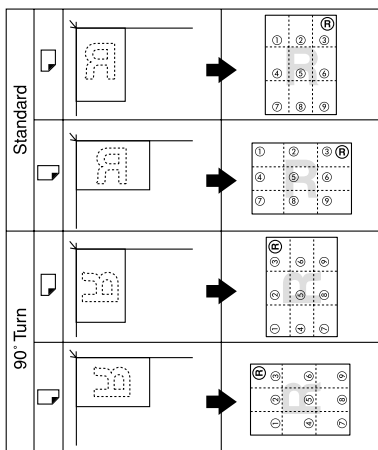

GCSTMPPE

- You can change the stamp position to top, bottom, left and right each way in 1mm, 0.1" steps. ⇒ "Stamp position" in P.222 "User Stamp 1/2-2/2".
- You can choose the default settings for the print page and the stamp position with the User Tools. ⇒ "Stamp condition" and "Stamp position" in P.222 "User Stamp 1/2-2/2".
- You can combine this function with only one Preset Stamp.

1 Press the [Edit/Stamp] key.

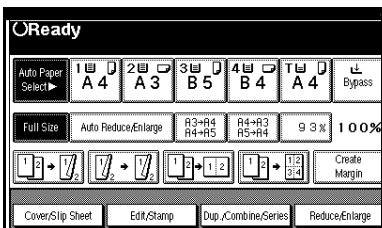

2 Press the [Stamp] key.

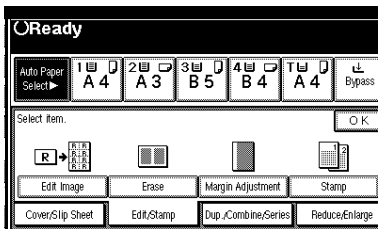

3 Press the [User Stamp] key.

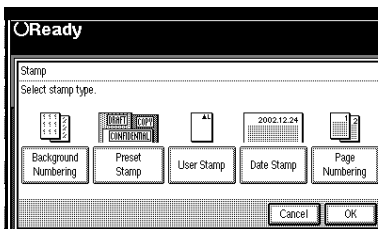

4 Select the stamp you require.

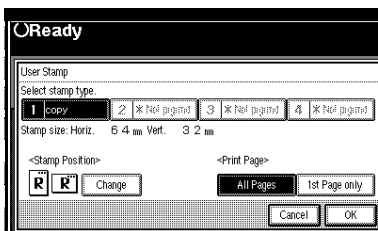

5 Press the [All Pages] or [1st Page only] key to select the print page.

To change the stamp position

1 Press the [Change] key.

- 2 Select the desired position.

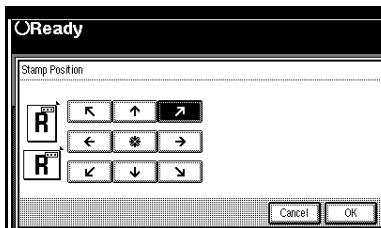

- 3 Press the [OK] key.

- 6 After you specified all the desired settings, press the [OK] key.

Note

- To cancel the settings, press the [Cancel] key.

- 7 Press the [OK] key.

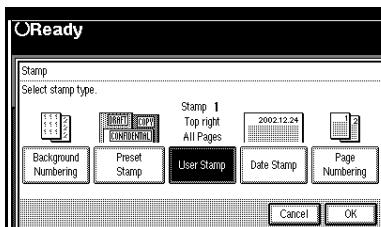

- 8 Set your originals, then press the [Start] key.

Program/Delete User Stamp

- 1 Make sure that the machine is in Copy mode.

- 2 Press the [User Tools/Counter] key.

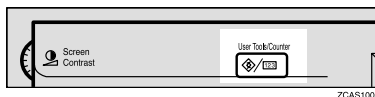

- 3 Press the [Copier/Document Server] key.

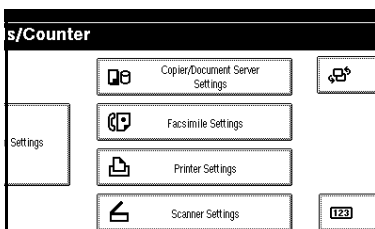

- 4 Press the [Stamp] key.

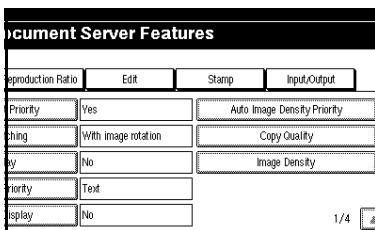

- 5 Press the [User Stamp] key.

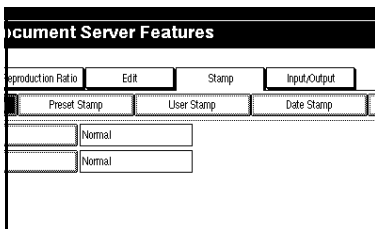

- 6** Press the **[Program/Delete Stamp]** key.

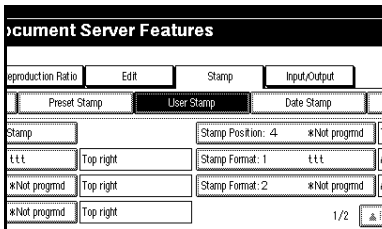

To program the User Stamp

- 1** Press the **[Program]** key.

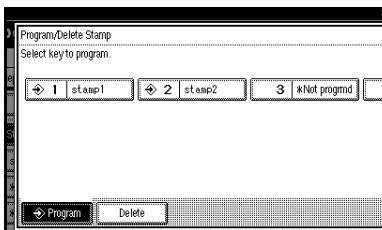

- 2** Press the stamp number (1 – 4) you want to program.

Note

- Stamp numbers with \rightleftarrows already have settings in them.
- If the stamp number is already being used, the machine will ask you if you wish to overwrite it — Press the **[Yes]** or **[No]** key.

- 3** Enter the user stamp name with the letter keys on the display panel.

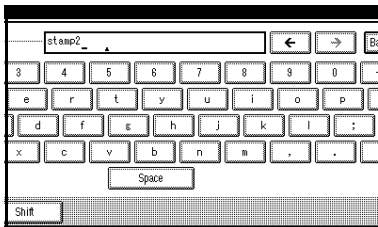

Note

- You can register up to 10 characters.
- For details on entering characters, refer to "Entering Text Characters" in the System Settings manual.

- 4** Press the **[OK]** key.
- 5** Enter the horizontal size of the stamp with the number keys, then press the **[#]** key.

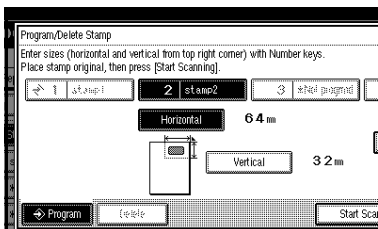

Note

- You can enter sizes within 10 – 432mm, 1.0" – 17.0" horizontal, and 10 – 297mm, 1.0" – 11.7" vertical. However, if the value exceeds the maximum value of the area (5,000mm², 7.75 inch²), it is corrected within the range of the area automatically.
- To change the value entered, press the **[Clear]** or **[Clear/Stop]** key and enter the new value.

- 6 Press the [Vertical] key, and enter the vertical size in the same way as step 5.
- 7 Set the user stamp on the exposure glass, and then press the [Start Scanning] key.

 **Note**

- The machine scans the original three times. Do not lift the document feeder until the main menu of the Copy/Document Server features appears.
- If you press the [Exit] key, the main menu of the Copy/Document Server features appears with nothing programmed.

- 8 Press the [Exit] key.

To delete the User Stamp

 **Important**

- You cannot restore a deleted stamp.

- 1 Press the [Delete] key.

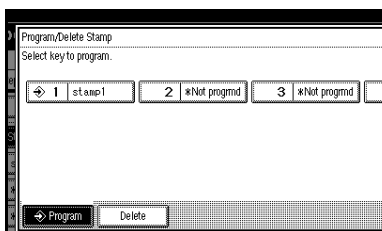

- 2 Press the stamp number (1 – 4) you want to delete.

 **Note**

- Only programs with  contain a user stamp.

- 3 Press the [Delete] key.

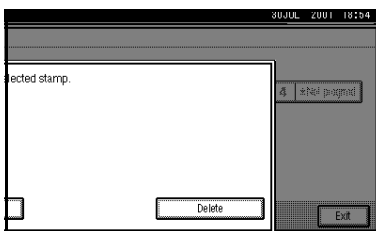

 **Note**

- To cancel the deletion, press the [Stop] key.

- 4 Press the [Exit] key.

- 5 Press the [Exit] key.

- 7 Press the [Exit] key.

The initial display appears.

Date Stamp

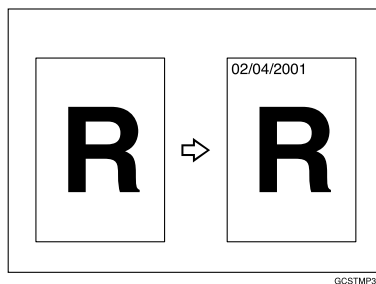

 **Limitation**

- You cannot use the bypass tray with this function.

 **Note**

- You can select the following styles:

- MM/DD/YYYY
- MM.DD.YYYY
- DD/MM/YYYY
- DD.MM.YYYY
- YYYY.MM.DD
- DD.JUN.YYYY

- ❑ You can change the Date Stamp settings with the User Tools. ⇒ P.223 "Date Stamp".
- ❑ The font and size of the Date Stamp can be changed with the User Tools. ⇒ "Font" and "Size" in P.223 "Date Stamp".
- ❑ You can select whether the Date Stamp is printed negative if it overlaps black parts of an image. ⇒ "Superimpose" in P.223 "Date Stamp".
- ❑ For how to set the date, see "Set Date" in the System Settings manual.
- ❑ You can choose the default settings for the stamp position with the User Tools. ⇒ "Stamp Position" in P.223 "Date Stamp".
- ❑ The relationship between the direction in which you set the original and the stamp position is as follows:

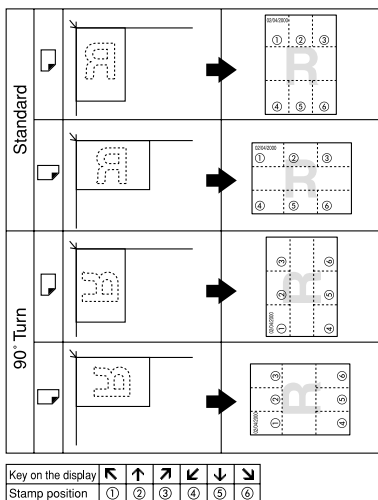

- ❑ You can change the stamp position to top, bottom, left and right each way in 1mm, 0.1" steps. ⇒ "Stamp Position" in P.223 "Date Stamp".

- ❑ If you combine this function with the Combine, Magazine or Booklet function, the page is stamped as follows.
 - Combined with the Combine function

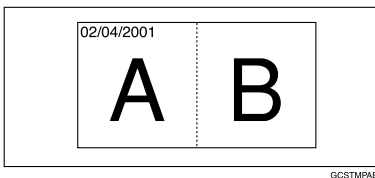

- Combined with the Magazine or Booklet function

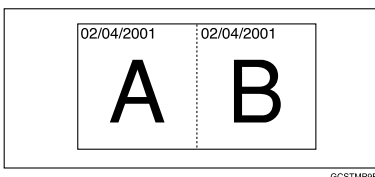

1 Press the [Edit/Stamp] key.

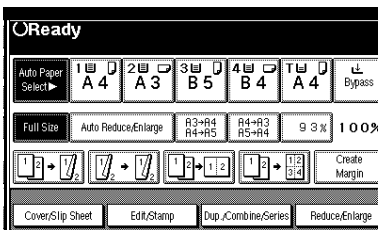

2 Press the [Stamp] key.

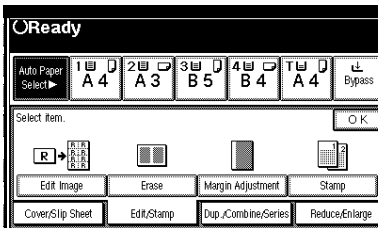

- 3** Press the [Date Stamp] key.

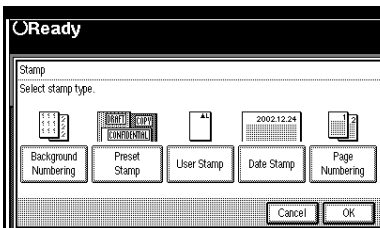

- 4** Press the [All Pages] or [1st Page only] to select the print page.

To change the style of date

- 1** Press the [Change Format] key.

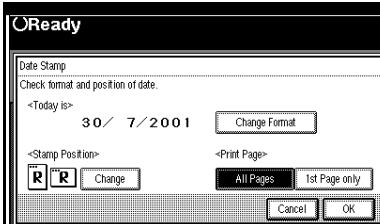

- 2** Select the format of date.

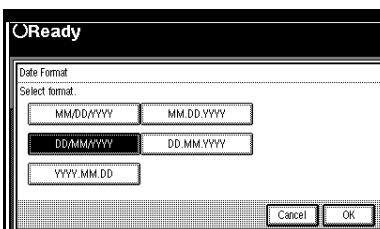

- 3** Press the [OK] key.

To change the stamp position

- 1** Press the [Change] key.

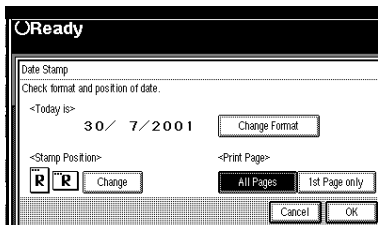

- 2** Select the desired position of the Date Stamp.

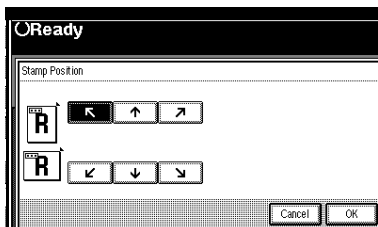

- 3** Press the [OK] key.

- 5** After you specified all the desired settings, press the [OK] key.

 **Note**

- To cancel the settings, press the [Cancel] key.

- 6** Press the [OK] key.

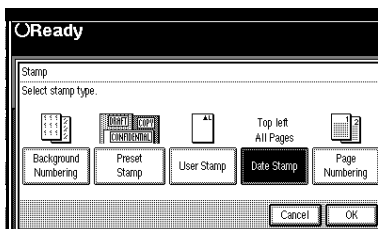

- 7** Set your originals, then press the [Start] key.

2

Page Numbering

Use this function to print page numbers on your copies. There are six types of Page Numbering (n is the total number of pages in your original):

- P1,P2,...Pn
- 1/n,2/n,...n/n
- -1,-2,...-n
- P.1,P.2,...P.n
- 1, 2...n
- 1-1,1-2,..1-n

Limitation

- You cannot use the bypass tray with this function.

Note

- You can change the Page Numbering settings with the User Tools. ⇒ P.224 "Page Numbering $1/2-2/2$ ".
- The font and size of Page Numbering can be changed with the User Tools. ⇒ "Font" and "Size" in P.224 "Page Numbering $1/2-2/2$ ".
- You can select whether the Page Numbering is printed negative if it overlaps black parts of image. ⇒ "Superimpose" in P.224 "Page Numbering $1/2-2/2$ ".
- You can choose the default settings for the stamp position with the User Tools. ⇒ "Stamp Position" in P.224 "Page Numbering $1/2-2/2$ ".
- You can choose the default settings for the stamp format with the User Tools. ⇒ "Stamp Format" in P.224 "Page Numbering $1/2-2/2$ ".

- The relationship between the direction in which you set the original and the Page Numbering orientation/position is as follows:

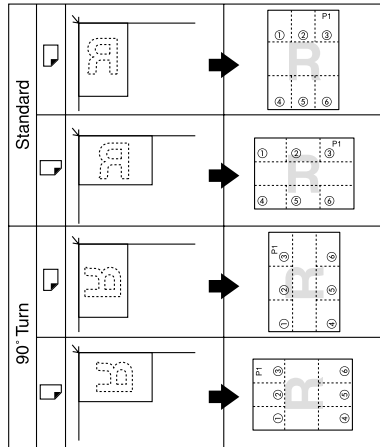

GCSTMPBE

- You can change the stamp position to top, bottom, left and right each way in 1mm, 0.1" steps. ⇒ "Stamp Position" in P.224 "Page Numbering $1/2-2/2$ ".
- If you combine this function with the Duplex (Top to Top) function and select the "P1, P2" or "1/n, 2/n" style, the page numbers on the back of the copy paper are printed as follows.

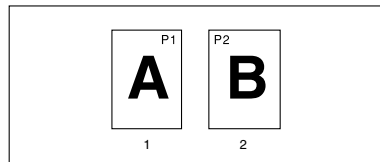

GCSTMPBE

1. Front
2. Back

- ❑ If you combine this function with the Duplex (Top to Top) function, you can change the setting to stamp on the back side in the same position as the front side. ⇒ “Duplex Back Page Stamping Position” in P.224 “Page Numbering $1/2-2/2$ ”.
- ❑ If you use this function with the Combine, Magazine, or Booklet function, the page is stamped as follows.

❖ Page Numbering per original

- Combined with 1 Sided/2 Sided in the Combine function

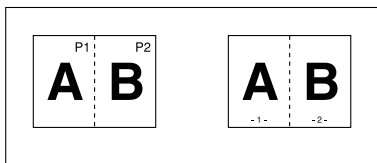

GCANPE0E

- Combined with the Magazine or Booklet function

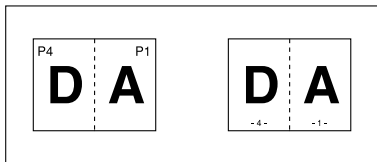

GCANPE1E

❖ Page Numbering per copy

- Combined with 1 Sided/2 Sided in the Combine function

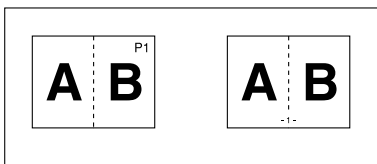

GCANPE2E

- ❑ ⇒ “Page Numbering In Combine” in P.224 “Page Numbering $1/2-2/2$ ”.

- ❑ If you use the “1-1, 1-2” style, you can print page numbers on the slip sheets in Designate or Chapters mode. ⇒ “Stamp on Designated Slip Sheet” in P.224 “Page Numbering $1/2-2/2$ ”.

1 Press the [Edit/Stamp] key.

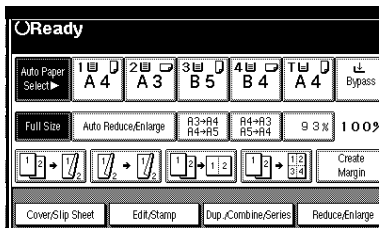

2 Press the [Stamp] key.

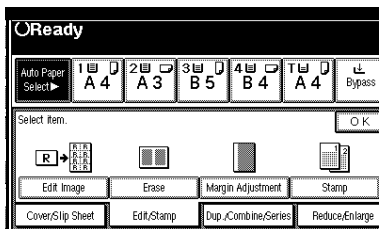

3 Press the [Page Numbering] key.

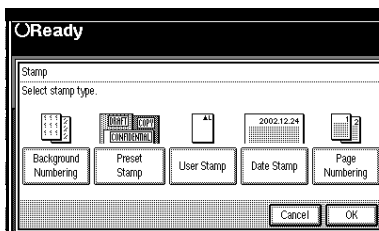

4 Select the format.

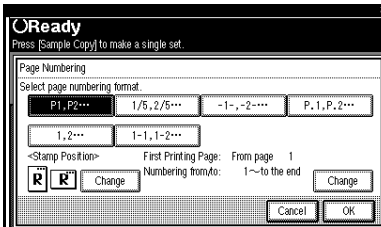

5 To change the stamp position, press the [Change] key.

If you do not wish to change the stamp position, go to step **7**.

6 Select the stamp position, then press the [OK] key.

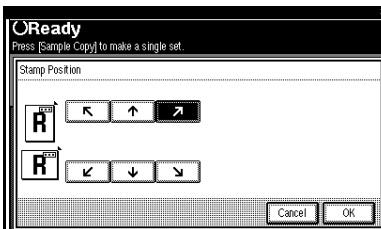

7 To change the first printing page and start number, press the [Change] key.

Note

- The display differs depending on the selected style.
- If you do not wish to change, press the [OK] key and set your originals, then press the [Start] key.

8 Specify the page and number.

If you selected (P1,P2..., -1-, -2-..., P. 1, P. 2..., 1, 2...,)

1 Press the [First Printing Page] key, then enter the original sheet number from which to start numbering with the number keys.

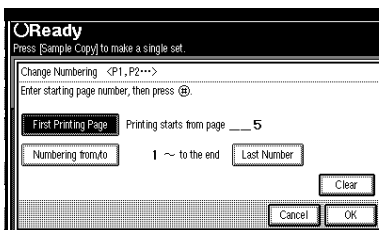

Note

- To change the number entered, press the [Clear] or [Clear/Stop] key and enter a new number.

2 Press the [#] key.

3 Press the [Numbering from/to] key, then enter the number from which to start numbering with the number keys.

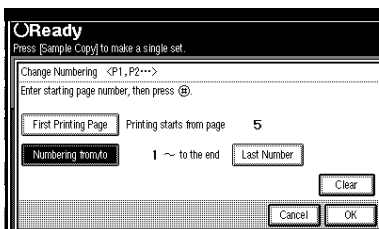

4 Press the [#] key.

- 5 Press the [Last Number] key, then enter the page number at which to stop numbering with the number keys.

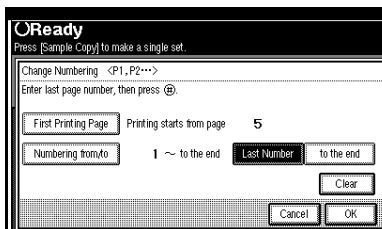

Note

- If you wish to print onto the last page, press the [to the end] key and go to step 10.

- 6 Press the [#] key.

If you selected (1/5,2/5...)

- 1 Press the [First Printing Page] key, then enter the original sheet number from which to start numbering with the number keys.

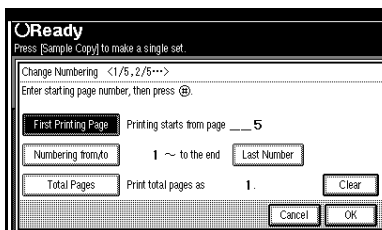

Note

- To change the number entered, press the [Clear] or [Clear/Stop] key and enter a new number.

- 2 Press the [#] key.

- 3 Press the [Numbering from/to] key, then enter the page number from which to start numbering with the number keys.

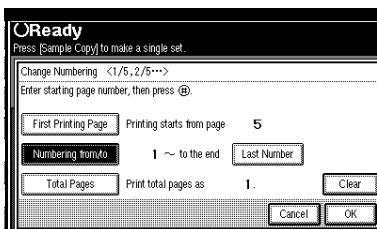

- 4 Press the [#] key.

- 5 Press the [Last Number] key, then enter the page number at which to stop numbering with the number keys.

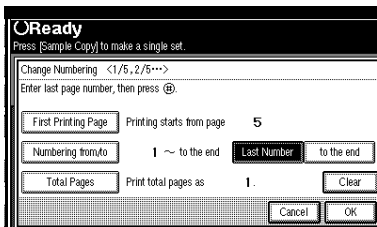

Note

- If you wish to print onto the last page, press [to the end] key and go to step 10.

- 6 Press the [#] key.

- 7 Press the [Total Pages] key, then enter the total number of original pages with the number keys.

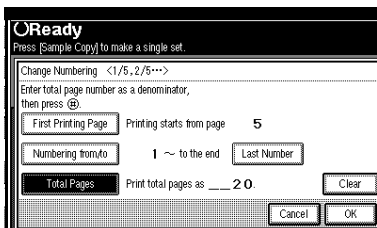

2

- 8 Press the [#] key.
- 9 Press the [OK] key.

If you selected (1-1, 1-2,...)

- 1 Press the [First Printing Page] key, then enter the original sheet number from which to start numbering with the number keys.

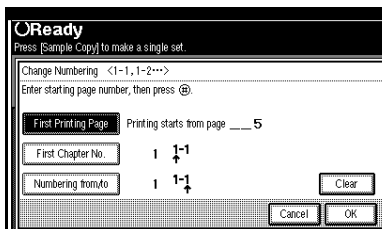

Note

- To change the number entered, press the [Clear] or [Clear/Stop] key and enter a new number.

- 2 Press the [#] key.
- 3 Press the [First Chapter No.] key, then enter the chapter number from which to start numbering with the number keys.

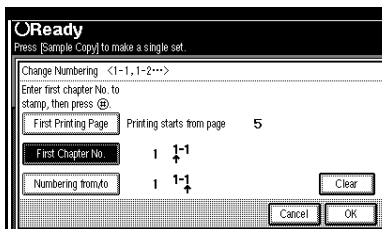

- 4 Press the [#] key.

- 5 Press the [Numbering from/to] key, then enter the page number from which to start numbering with the number keys.

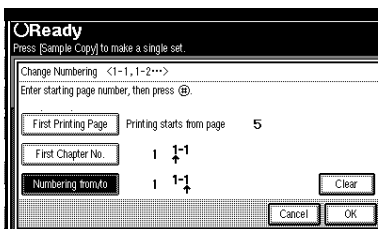

- 6 Press the [#] key.
- 7 Press the [OK] key.

- 9 Press the [OK] key.

Note

- To change the settings after pressing the [OK] key, press the [Change] key and enter the new value.

- 10 Press the [OK] key.

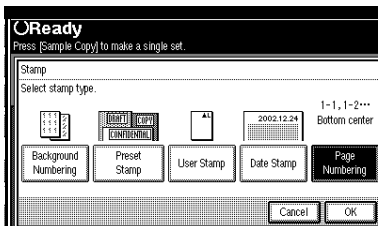

Note

- To cancel the settings, press the [Cancel] key.

- 11 Set your originals, then press the [Start] key.

Cover/Slip Sheet

Using this function, you can add or insert cover or paper designate.

There are four types in this function:

❖ Front Cover

The first page of your originals is copied on a specific paper sheet for covers.

❖ Front/Back Cover

The first and last pages of your originals are copied on specific paper sheets for covers.

❖ Paper Designate

Use this function to have certain pages of your original copied onto slip sheets.

❖ Chapter

If you specify the first page of each chapter with this function, those pages will always appear on the front of copies when using 1 sided → 2 sided mode.

📄 Preparation

Before selecting this function, set the tray for front cover paper and slip sheet paper. ⇒ “Cover”, “Slip Sheet 1” and “Slip Sheet 2” in the System Settings manual.

The cover or slip sheets should be identical in size and direction with the copy paper.

💡 Limitation

- ❑ You cannot set the copy paper in the bypass tray. Only set the cover or slip sheets in the bypass tray.

📝 Note

- ❑ If Blank mode is selected, the cover will not be counted as a copy.

Front Cover

The first page of your originals is copied on specific paper sheet for covers, or a cover sheet is inserted before the first copy.

❖ Copy

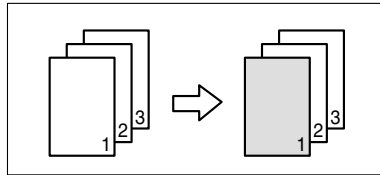

❖ Blank

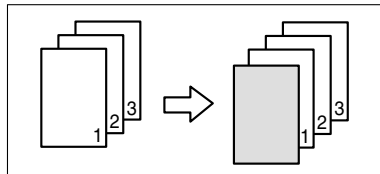

📝 Note

- ❑ You can specify whether to make a copy on a sheet for covers. If you select **[Copy]**, the first page will be copied on the cover sheet. If you select **[Blank]**, a cover sheet will just be inserted before the first copy.
- ❑ When choosing **[Copy]**, select whether the front and back covers are copied single-sided (“1 Sided Only”) or double-sided (“Duplex Copy”). ⇒ “Cover” in the System Settings manual.

□ In “Cover” of the User Tools (System Settings), if you selected “Mode Selected” for “Tray Display” setting, the machine refers to the settings in “Cover” about whether the front and back covers are copied single-sided (“1 Sided Only”) or double-sided (“Duplex Copy”). If you selected “Display Always” for “Tray Display”, the machine refers to the settings in “Special Paper Indication” about whether the front and back covers are copied single-sided (“1 Sided Copy”) or double-sided (“Duplex Copy”). ⇒ “Special Paper Indication” and “Cover” in the System Settings manual.

□ When you use this function with Combine mode, you can specify whether to combine the front cover or not. ⇒ “Front Cover Copy in Combine” in P.218 “Edit 2/2”.

1 Press the [Cover/Slip Sheet] key.

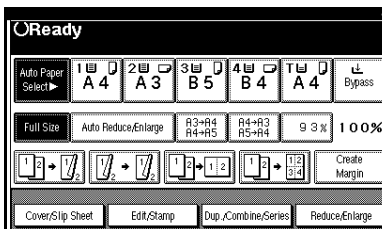

2 Press the [Front Cover] key.

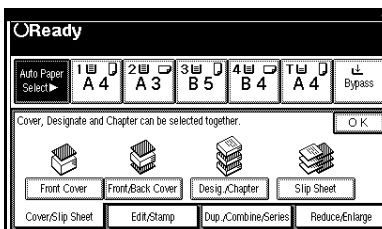

3 Select [Copy] or [Blank] for a cover sheet, and then press the [OK] key.

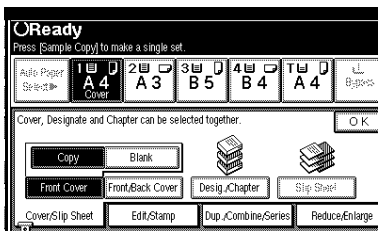

4 Select the paper tray containing the non-cover sheet paper.

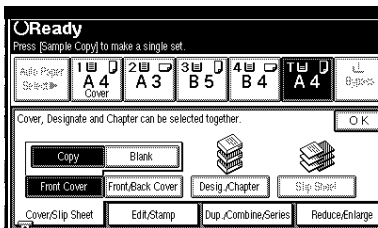

5 Set your originals in the document feeder, then press the [Start] key.

Front/Back Covers

The first and last pages of your originals are copied on specific paper sheets for covers.

◆ Copy

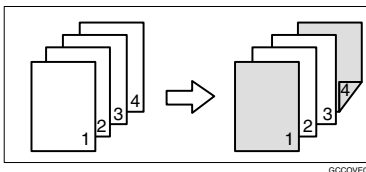

◆ Blank

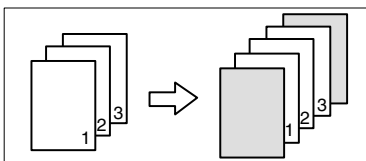

Note

- You can specify whether to make a copy on a cover sheet. If you select **[Copy]**, the first and last pages will be copied on the cover sheets. If you select **[Blank]**, a cover sheet will just be inserted before the first copy and another sheet after the last copy.
- When choosing **[Copy]**, select whether the front and back covers are copied single-sided (“1 Sided Only”) or double-sided (“Duplex Copy”). ⇒ “Cover” in the System Settings manual.
- In “Cover” of the User Tools (System Settings), if you selected “Mode Selected” for “Tray Display” setting, the machine refers to the settings in “Cover” about whether the front and back covers are copied single-sided (“1 Sided Only”) or double-sided (“Duplex Copy”). If you selected “Display Always” for “Tray Display”, the machine refers to the settings in “Special Paper Indication” about whether the front and back covers are copied single-sided (“1 Sided Copy”) or double-sided (“Duplex Copy”). ⇒ “Special Paper Indication” and “Cover” in the System Settings manual.

1 Press the **[Cover/Slip Sheet]** key.

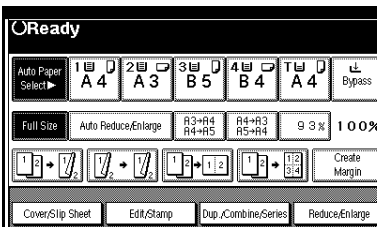

2 Press the **[Front/Back Cover]** key.

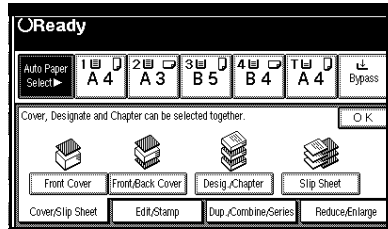

3 Select **[Copy]** or **[Blank]** for the cover sheets, and then press the **[OK]** key.

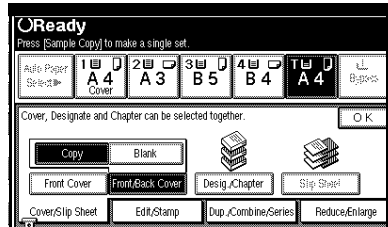

4 Select the paper tray containing the non-cover sheet paper.

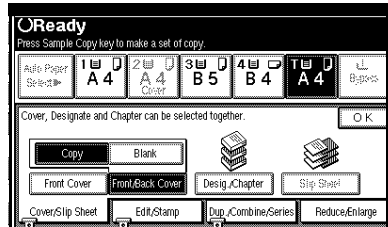

5 Set your originals in the document feeder, then press the **[Start]** key.

2

Designate

Use this function to have certain pages of your original copied onto slip sheets.

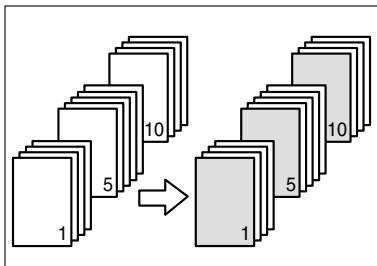

Preparation

Before using this function, set the special paper tray for slip sheets. ⇒ “Slip Sheet 1”, “Slip Sheet 2” in the System Settings manual.

Limitation

- You cannot use this function with Slip Sheet mode.

Note

- You can specify the pages up to 20.
- When Combine mode (“1 Sided → 2 Sided”) has been selected, the page numbers you designate will always be copied onto the front of copies in the same way as Chapters mode.

1 Press the [Cover/Slip Sheet] key.

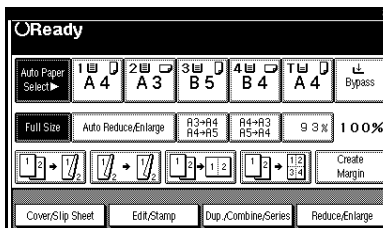

2 Press the [Desig./Chapter] key.

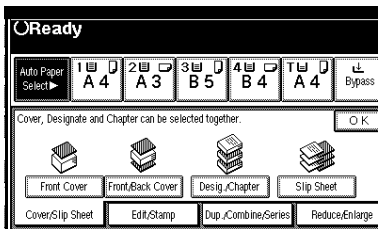

3 Press the key to select the chapter number.

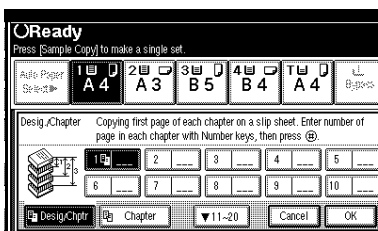

4 Enter the page number of the original's location you want to copy onto a slip sheet with the number keys. Then, press the [#] key.

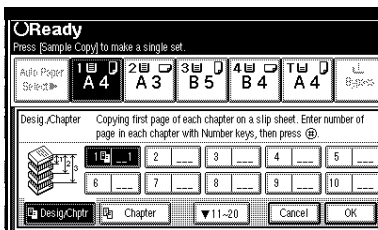

Note

- To change the value entered, press the [Clear] or [Clear/Stop] key and enter the new value.

5 Select the paper tray for slip sheets.

6 To specify another page location, repeat steps 3 to 5.

Note

- To select chapters 11 to 20, press the [▼11~20] key.

- 7** When you wish to finish specifying page location, press the [OK] key.

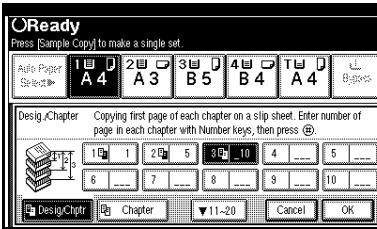

This display shows example settings.

Note

- To change the number entered, enter the new number in the same way as steps **8** to **7**.

- 8** Select the paper tray containing the non-slip sheet paper.

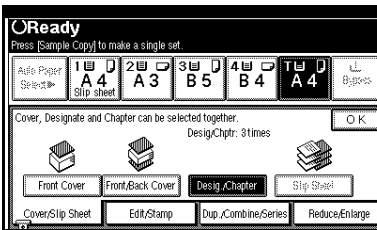

- 9** Set your originals, then press the [Start] key.

Chapter

The page locations you specify with this function will appear on the front of copy sheets.

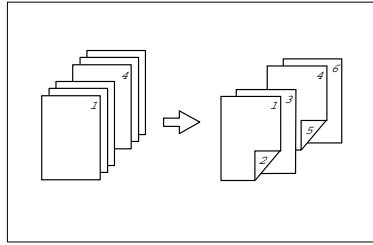

Preparation

Before selecting this function, press the [Dup./Combine/Series] key and select Duplex (1 Sided → 2 Sided) mode or Combine mode.

Limitation

- You cannot use this function with Slip Sheet mode.

Note

- You can specify the pages up to 20.
- This function can be used only when you use the Duplex (1 Sided→2 Sided) or Combine function.
- This function can be combined with the Designate function.

- 1** Press the [Cover/Slip Sheet] key.

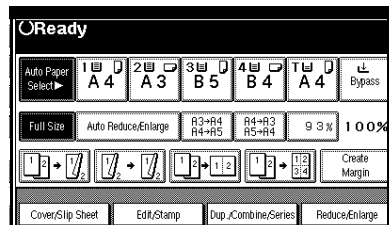

2 Press the [Desig./Chapter] key.

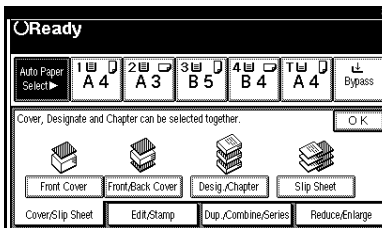

3 Press the [Chapter] key.

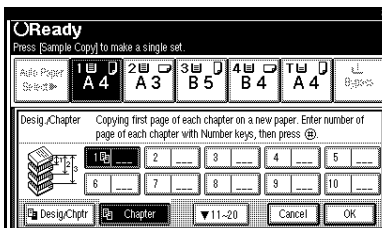

4 Enter the page location of the first page of the first chapter with the number keys. Then, press the [#] key.

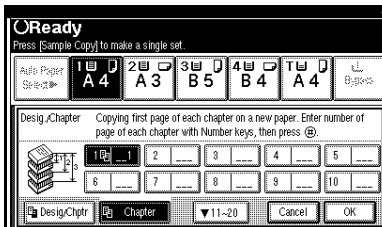

Note

- To change the value entered, press the [Clear] or [Clear/Stop] key and enter the new value.

5 To specify another page location, repeat steps 3 to 5.

Note

- To select chapters 11 to 20, press the [▼11-20] key.

6 When you finish specifying the page location, press the [OK] key.

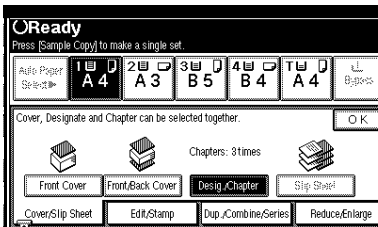

This display shows example settings.

Note

- To change the number entered, enter the new number in the same way as in steps 3 to 5.

7 Set your originals, then press the [Start] key.

Slip Sheets

Every time the original's page changes, a slip sheet is inserted. This function can be used to insert a slip sheet automatically between each OHP transparency copied or used as a stack function. You can also copy onto the inserted slip sheets.

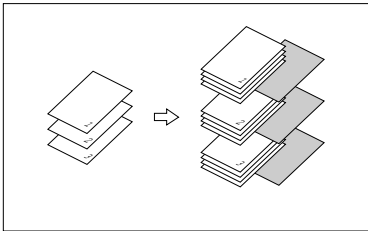

Preparation

Before selecting this function, specify the paper tray for slip sheets. ⇒ "Slip Sheet 1", "Slip Sheet 2" in the System Settings manual.

Limitation

- You cannot use this function with Chapters and Paper Designate modes.

Note

- Set the slip sheets in the same orientation as originals.
- You can specify whether to make copies onto the inserted slip sheets or not.
- If you do not copy onto slip sheets, they are excluded from the number of copies counted.

When using OHP transparencies set on the bypass tray

Blank

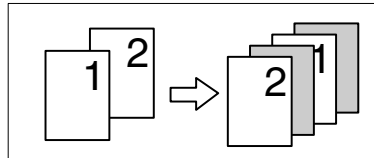

Note

- Press the [#] key and set the "Special Paper" setting to **[OHP Sheet]**. ⇒ P.60 "When Copying onto OHP Transparencies or Thick Paper".

1 Press the [Cover/Slip Sheet] key.

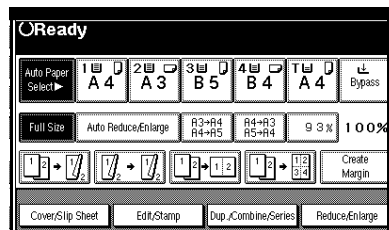

2 Press the [Slip sheet] key.

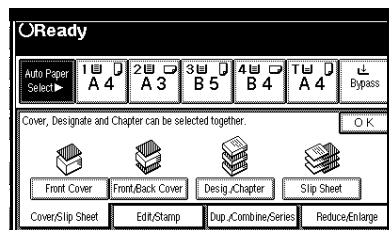

- 3 Select **[Copy]** or **[Blank]**, followed by the **[OK]** key.

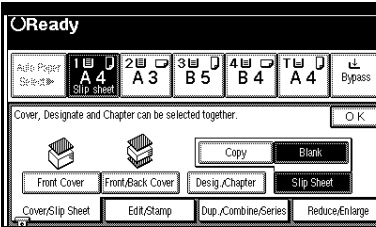

- 4 Select the paper tray containing the non-slip sheet paper.

When using OHP transparencies, open the bypass tray.

- 5 Set your originals, then press the **[Start]** key.

2

3. Document Server

Overview

The Document Server enables you to save documents in the machine memory and then edit and print them as you want.

There are three ways to save documents.

- Scanning from the document feeder
- Scanning from the exposure glass
- Data sent from a computer.

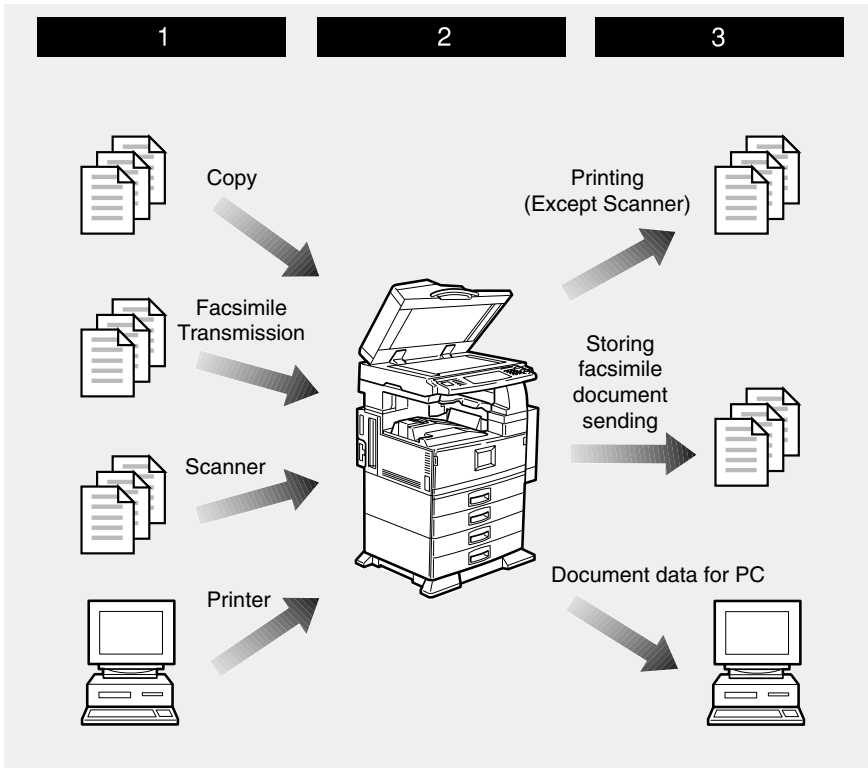

©CAH050E

Process

1 Prepare the documents you want to save by copying, fax transmitting, scanning, and PC data.

2 Save the documents.

- The documents are saved in the machine memory.

3 Print the documents, send fax, and transfer the documents and the data to PC.

- You can print saved documents with any settings you desire at any time.
- Scanned documents data can be transferred to PC.
- You can resend saved documents you desire at any time.

Important

- Do not turn off the main power switch when the Operation Switch is on or lit. If you turn it off during an operation, memory or hard disk might be damaged.
- Avoid any strong shocking to the machine, the hard disk might be damaged, and stored files will be deleted. For precautionary reasons, files should be copied to another local computer.
- If trouble occurs in the internal hard disk unit of the machine, data saved on the hard disk may be lost. Therefore, the user should avoid using the internal hard disk as a recording and storage medium for important data. We assume no responsibility for any damage suffered by the user due to loss of data.

Limitation

- Data for documents in the Document Server function list that were scanned in using the Scan function are not displayed.
- The stored documents by scanning are not available to print.
- You can facsimile sending but the documents must be stored in facsimile feature. This function must be operated by facsimile feature.
- Optional Desk Top Binder V2 Professional or Desk Top Binder V2 Lite are required for transferring data to your computer.

Features and Benefits

On Demand Printing

Use to print any saved document as required.

◆ Your current situation might be...

- When you need to print multiple sets of documents 2-sided and stapled together, you normally print the originals, make duplex copies and then staple them together manually.

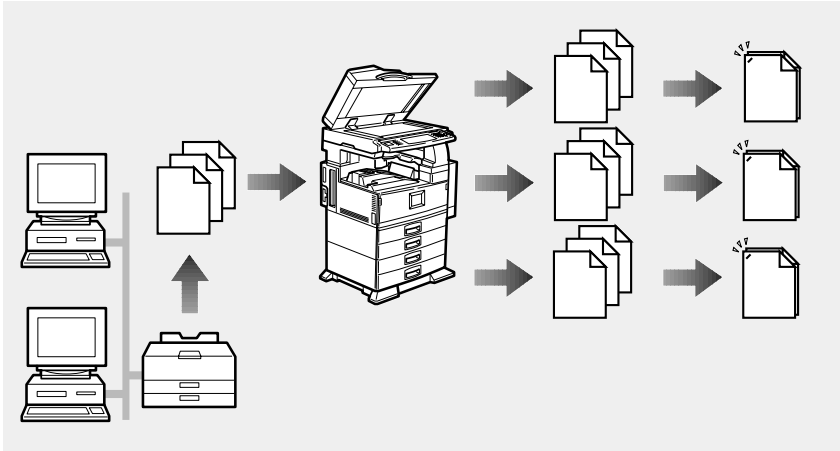

❖ With the Document Server

If you save your document in the Document Server, you can print it out at any time with the necessary print settings, such as duplex and stapling. Your documents will not be confused with those of others in the exit tray.

You can store fax documents, document data so that you can print them whenever necessary.

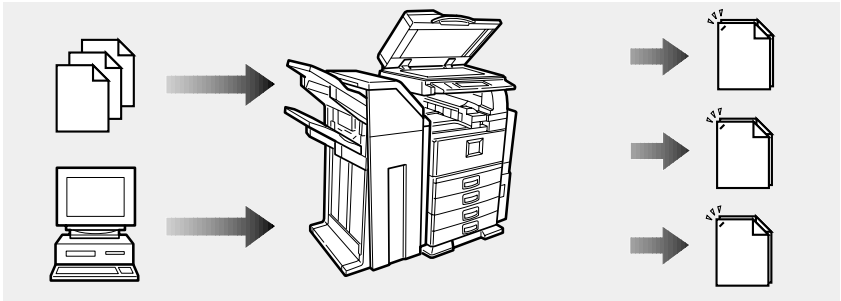

GCAH060E

Note

- Stapling and punching require the installation of the optional finisher.
- You can use a password to prevent others from printing saved documents.

File Merge Printing

You can combine multiple scanned documents to print them in one set.

◆ **Your current situation might be...**

You want to combine several originals that are different in density, size, and paper weight, e.g.

You can merge documents that were created with different applications or that were created separately on different computers.

You can merge documents that were sent from a computer with paper originals that have been scanned.

- Scrapped and pasted originals
- Photo originals
- One sided originals
- Two sided originals

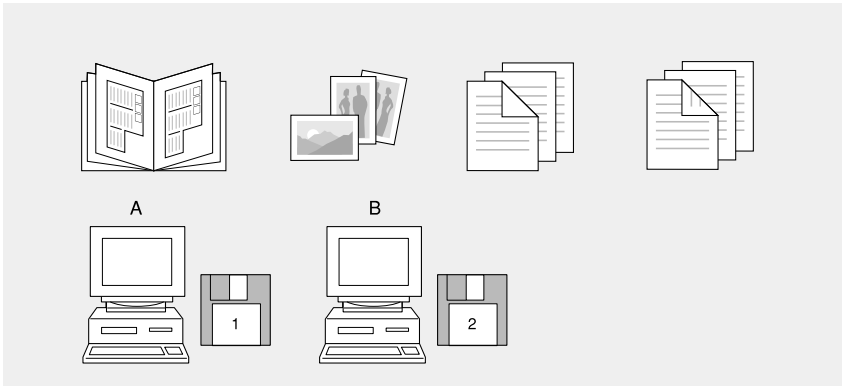

GCAH070E

◆ With the Document Server

Set the print order to print documents together.

Merge and print fax documents, document data sent, and originals that have been scanned.

Merge documents created with different applications or created on different computers.

Store electronic originals created by a computer on the network, and originals that have been scanned using the document feeder.

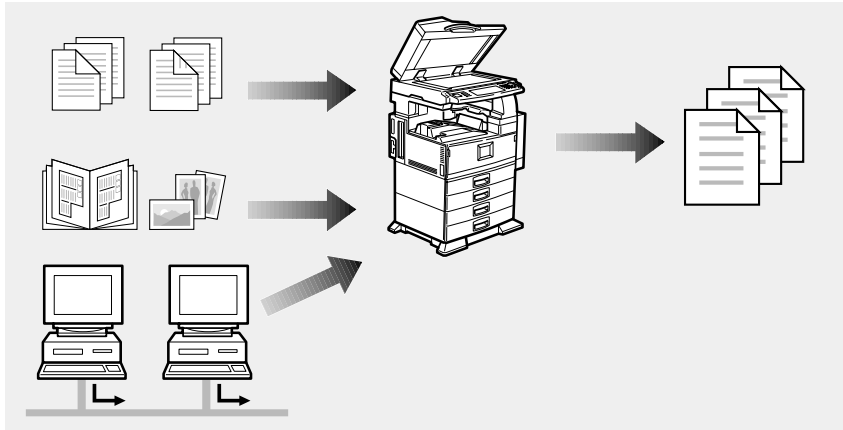

GCAH080E

Note

- You can check the print result by printing a sample set before making a large print run by pressing the **[Sample Copy]** key. If you are not satisfied with the print result of some pages of the set, you have only to scan that part again.

Facsimile Resend

You can print or resend a sent document received by fax. This is useful when you want to send a large document that needs to be sent several times, since you do not have to scan the document each time.

❖ **You current situation might be...**

- When you need to retransmit multiples sets of the same documents.

❖ **With the Document Server**

You can send the original data stored in memory whenever necessary. You can merge and send data stored from a previous fax with additional scanned originals.

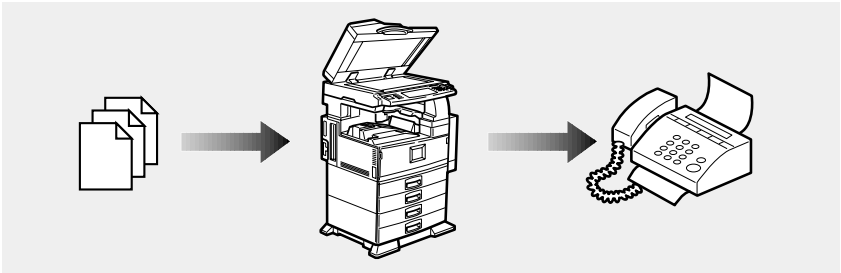

Operation from a Computer

If you install Desk Top Binder V2 Professional or Desk Top Binder V2 Lite on your computer you can check the display of electronic data, select the finish settings and print it. You can also delete data stored in the Document Server. In addition, you can also export documents stored in the Document Server as a file on your computer.

You can also perform tasks on data stored in the Document Server from your computer, rather than from near the machine.

Note

- You can operate from your computer as follows:
 - Search by File Name and User Name.
 - Indicate easily 1 st Page of your documents.
 - Indicate the documents infomation, change the file name and the password.
 - Delete the documents.
 - Copy the documents to your computer.
 - Print the documents.
 - Send the stored facsimile documents.
- Optional Net work Interface board and 32 MB memory or Printer Scanner unit are required for operating from your computer. Desk Top Binder V2 Professional or Desk Top Binder V2 Lite must be installed on your computer.

Reference

More detail information, refer to Desk Top Binder V2 Professional/Lite manuals.

Scanning Originals

You can scan the originals you want to save in the Document Server using the control panel of the machine. The original can be set either on the exposure glass or into the document feeder.

The saved documents will automatically be named in the order of scanning as “COPY0001”, “COPY0002”....

Note

- Based on the factory settings, the machine automatically deletes documents from the Document Server one day (24 hours) after each document was saved. The user can disable the automatic deletion of documents or change the automatic deletion period, for example, to several days. ⇒ “Auto File Delete” in P.226 “Input/Output”
- You can change the file names that are assigned automatically.
- You can use a password to prevent others from printing saved documents.

Scanning in Document Server mode

1 Press the [Document Server] key.

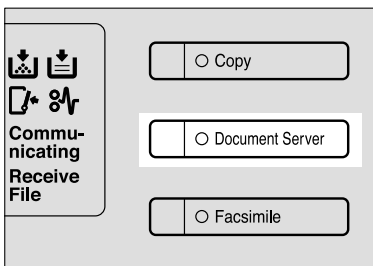

ZCAS110N

The “Select Files to Print” display appears.

2 Press the [Scan Original] key.

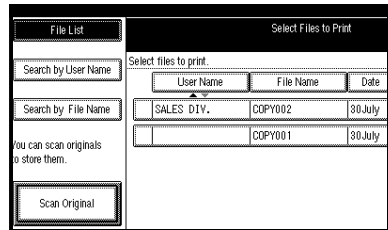

The “Scan Original” display appears.

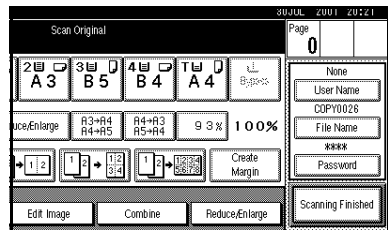

3 Enter a file name, user name, or password if necessary.

Note

- If you do not wish to register a file name, go to step 4.
- If you do not register a file name, it is stored automatically.

To set the file name

1 Press the [File Name] key.

3

- Enter the new file name using the letter keys on the display panel.

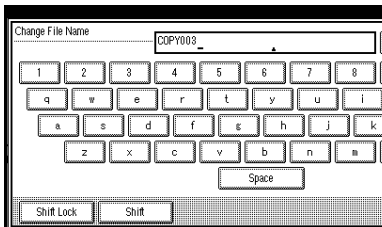

Reference

For details on entering characters, refer to "Entering Text Characters" in the System Settings manual.

- Press the [OK] key.

To set the user name

- Press the [User Name] key.
- Enter the new user name using the letter keys on the display panel.

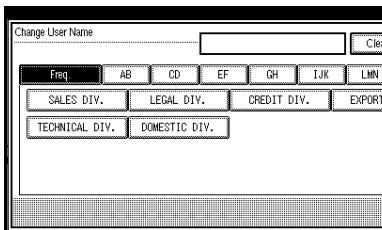

Note

- If you want to enter non-registered name, press the [Non-registered Name] key, then enter the new user name.

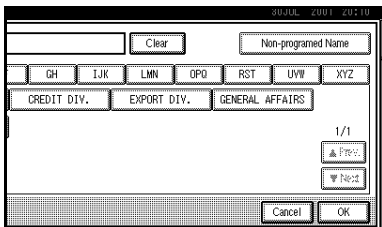

To set the password

- Press the [Password] key.
- Enter the password using the number keys (4 digits).

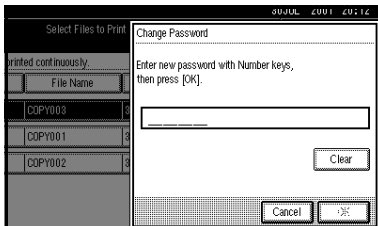

Note

- To change the number entered, press the [Clear] or [Clear/Stop] key and enter a new number.

- Press the [OK] or [#] key.

- Set your originals either on the exposure glass or into the document feeder.

Reference

For more information on the types of originals that can be set and how to set them, ⇒ P.29 "Setting Originals".

- Make any desired settings.

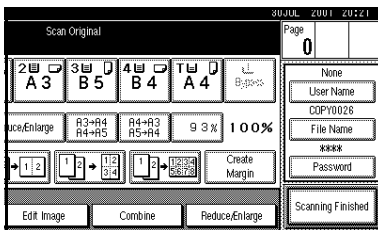

Note

- Press the [Scanning Finished] key to cancel the file name, password, or print settings and return to the "Select Files to Print" display.

Reference

For details, see the explanations of each function in this manual.

6 Press the [Start] key.

The document is saved in the Document Server. The saved documents are displayed on the “Select Files to Print” display.

Note

- If you have set your originals in the document feeder, the “Select Files to Print” display appears automatically after all originals have been scanned.
- If you have set your originals on the exposure glass, press the [Scanning Finished] key after all originals have been scanned. The “Select Files to Print” display appears.
- To stop scanning, press the [Clear/Stop] key.
- To resume the paused scanning job, press the [Resume] key in the confirmation dialog box. To delete the saved images and cancel the job, press the [Cancel] key.
- When storing a password, **1** appears on the left side of the file name.

7 Press the [Scanning Finished] key.

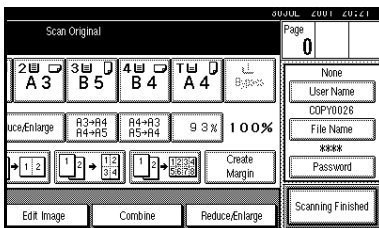

To change the file name, user name, or password

- 1 Press the line of the document whose file name, user name, or password you want to change.

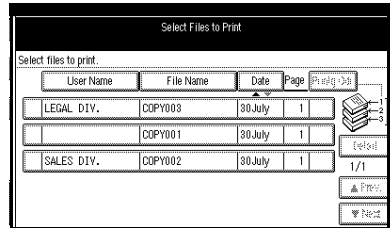

- 2 If you select a document which requires a password, the “Input the Password” window appears. Input the password using the number keys, then press the [OK] key.
- 3 Press the [File Management] key.

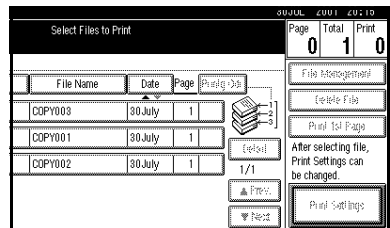

- 4 Press the [Change File Name], [Change User Name], or [Change Password] key.

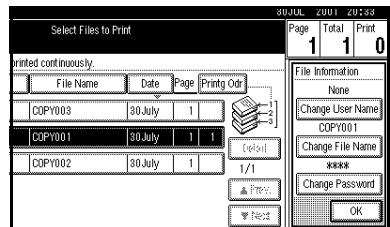

- 5 Enter the new file name, user name, or password using the letter keys or number keys.
- 6 Press the [OK] key.

Scanning in Copy mode

1 Press the **[Copy]** key.

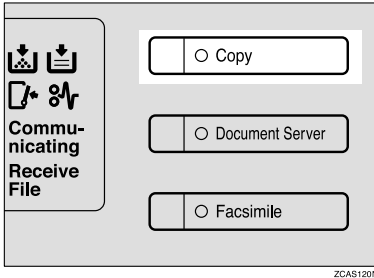

Copy display appears.

2 Press the **[Stored File]** key.

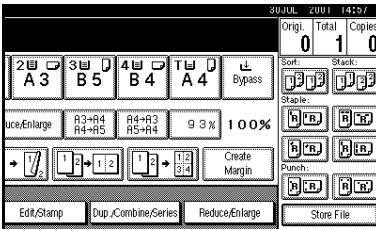

3 Enter a file name, user name, or password if necessary.

Reference

For details about settings, ⇒ “Scanning in Document Server mode” step 3.

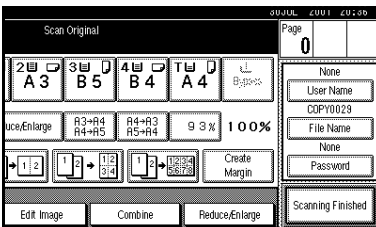

4 Set your originals.

Reference

For more information on the types of originals that can be set and how to set them, ⇒ P.29 “Setting Originals”.

5 Make the scanning settings for the original.

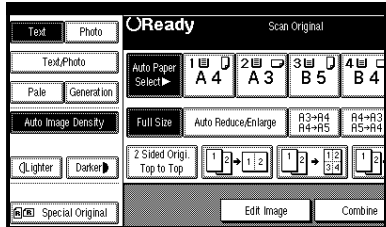

Reference

For details, see the explanations of each function in this manual.

6 Press the **[Start]** key.

Note

- To stop scanning, press the **[Clear/Stop]** key.
- To resume the paused scanning job, press the **[Resume]** key in the confirmation dialog box. To delete the saved images and cancel the job, press the **[Cancel]** key.
- To check if the document has been stored, press the **[Document Server]** key to display the document selection screen.

Printing Saved Documents

You can print any of the documents saved in the Document Server.

Follow these steps to select a document and print it out.

1 Press the **[Document Server]** key.

The “Select Files to Print” display appears.

2 Press the line for the document you want to print.

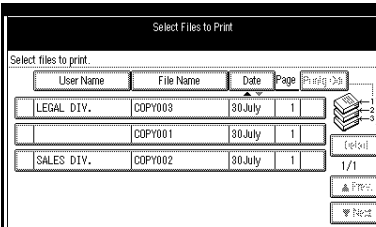

The selected line is highlighted.

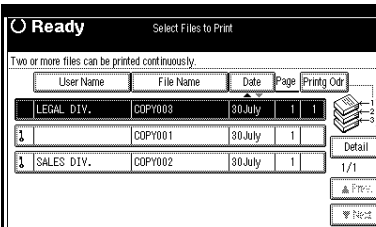

Note

- You can search the document you desire by the file name or the user name. ⇒ P.160 “To Search by File Name”.
- You can sort the files in order of **[User Name]**, **[File Name]**, or **[Date]**. Press the key you want to sort by.
- If the desired file name is not shown, see the next or previous screen using the **[▼ Next]** and **[▲ Prev.]** keys.

- If you cannot choose the desired document by its name, you can print the first page to check the contents. Press the line for the desired document, and press the **[Print 1st Page]** key followed by the **[Start]** key.
- Press the selected line again to cancel the print job.
- If you select a document which requires a password, the “Input the Password” window appears. Enter your password using the number keys, then press the **[OK]** key. To delete the value entered, press the **[Clear]** or **[Clear/Stop]** key. To cancel a selected document, press the **[Cancel]** key.

3 To print more than one document, repeat step 2 to select the desired documents in the order you want to print them out.

The selected order is shown in the priority column next to the selected document(s).

Note

- To change the print order, press the highlighted lines to return to the normal conditions, then select them again in the order you want to print.
- Press the **[Clear Modes]** key to cancel all the settings.
- If you press the **[Printng Odr]** key, the selected order is displayed in order.

- 4** If you need to change any of the print settings, press the **[Print Settings]** key.

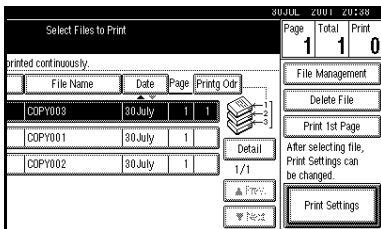

The “Print Settings” display appears.

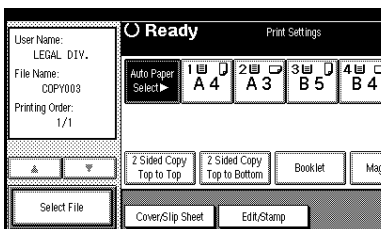

Note

- The print settings remain in the machine after printing.
- The print settings of the document you select first are applied to the merged documents.
- If you select multiple files, you can confirm the file names or print order of the files you selected in step **3** by scrolling through the list with the **[▼]** and **[▲]** keys.
- Press the **[Select File]** key to return to the “Select Files to Print” display.

Reference

For details, see the explanations of each function in this manual.

- 5** Enter the required number of prints using the number keys.

Note

- Up to 999 can be entered.
- To change the value entered, press the **[Clear/Stop]** key and enter new value.
- If you print more than one set using the Sort function, you can check the print result by printing out only the first set. ⇒ P.159 “Sample Printing”.

- 6** Press the **[Start]** key.

The machine starts printing.

Note

- To pause the print job, press the **[Clear/Stop]** key. In the confirmation dialog box, press the **[Resume]** key to resume it, or press the **[Cancel]** key to cancel it.

Sample Printing

If you print multiple sets using the Sort function, you can check if the print order or the print settings are correct by printing out only the first set using the **[Sample Copy]** key.

! Limitation

- This function can be used only when the Sort function has been turned on.

1 Follow steps **1** to **5** of the preceding procedure.

2 Press the **[Sample Copy]** key.

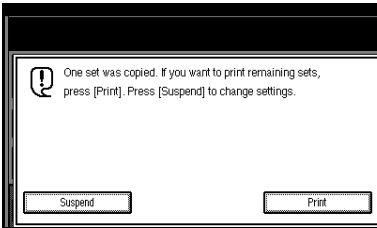

3 After the first set is printed out, press the **[Print]** key to print the rest of the print job. Press the **[Suspend]** key to cancel it and return back to the “Print Settings” menu for changing the setting.

Print First Page

You can print the first page of the document selected in the “Select Files to Print” display to check the contents.

If more than one document is selected, the first page of each document is printed.

1 Press the line for the desired document(s) in the “Select Files to Print” display, and press the **[Print 1st Page]** key.

2 Press the **[Start]** key.

The first page is printed out.

Searching Saved Documents

You can use either the **[Search by File Name]** or **[Search by User Name]** keys to search for documents stored on the document server. You can also list the stored documents in the order you prefer. If you install Desk Top Binder V2 Professional or Desk Top Binder V2 Lite on your computer, you can search and rearrange the documents from your computer.

❖ Search by File Name

You can search the documents stored in the Document Server by the file name.

❖ Search by User Name

You can search the documents stored in the Document Server by the user name.

To Search by File Name

This searches for documents on the document server that match a file name.

1 Press the **[Document Server]** key.

2 Press the search by **[File Name]** key.

3 Enter the file name using the letter keys.

🔍 Reference

For details on entering characters, refer to "Entering Text Characters" in the System Settings manual.

4 Press the **[OK]** key.

Only the files beginning with the letters appear in the "Select Files to Print" display.

📌 Note

- ❑ To display all the files saved in the Document Server, press the **[All the files]** key.

To Search by User Name

This searches for documents on the document server that match a user name.

1 Press the **[Document Server]** key.

2 Press the search by **[User Name]** key.

3 Enter the user name using the letter keys.

🔍 Reference

For details on entering characters, refer to "Entering Text Characters" in the System Settings manual.

4 Press the **[OK]** key.

Only the files beginning with the letters appear in the "Select Files to Print" display.

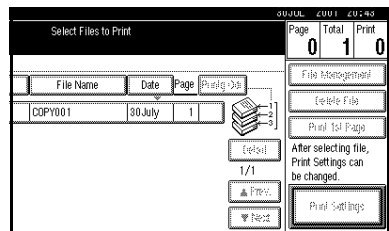

📌 Note

- ❑ To display all the files saved in the Document Server, press the **[All the files]** key.

To Check the Details of Stored Documents

- 1 Select the document for which you want detailed information.

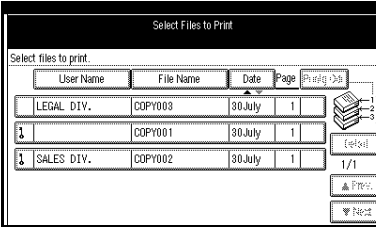

- 2 Press the [Detail] key.

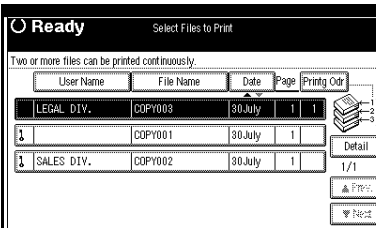

The detailed information about the document is displayed.

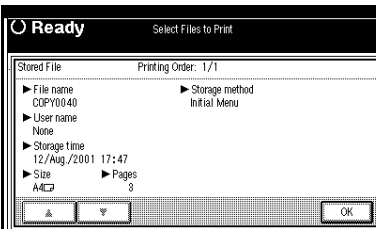

Note

- If you have selected several documents, use the [▲] [▼] keys to view the details of each document.

Deleting Saved Documents

You should delete any of the saved documents using the control panel of the machine.

This section describes how to delete saved documents.

Important

- You can save up to 3,000 documents in the Document Server. No more documents can be saved, when there are 3,000 documents in the Document Server. You should delete unnecessary documents.
- You can set the timer to delete the documents stored in the Document Server with the User Tools. ⇒ “Delete All Files” in the System Settings manual.

Note

- You can delete all the saved documents at a time with the User Tools. ⇒ “Delete All Files” in the System Settings manual.

Follow these steps to delete saved documents.

1 Press the **[Document Server]** key.

The “Select Files to Print” display appears.

2 Select a document you want to delete by pressing the name of it.

The selected name is highlighted.

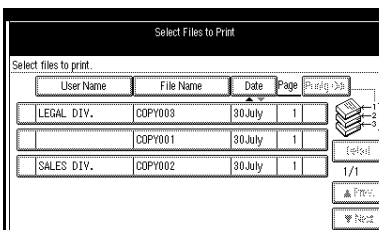

Note

- You can search the document you desire by the file name or the user name. ⇒ P.160 “To Search by File Name”.
- You can sort the files in order of **[User Name]**, **[File Name]**, or **[Date]**. Press the key you want to sort by.
- If the desired file name is not shown, see the next or previous screen using the **[▼ Next]** and **[▲ Prev.]** keys.
- If you cannot choose the desired document by its name, you can print the first page to check the contents. Press the line for the desired document, and press the **[Print 1st Page]** key followed by the **[Start]** key.
- Press the selected line again to cancel the print job.
- If you select a document which requires a password, the “Input the Password” window appears. Enter your password using the number keys, and press the **[OK]** key. To delete the value entered, press the **[Clear]** or **[Clear/Stop]** key. To cancel a selected document, press the **[Cancel]** key.

3 Repeat step **2** if you want to select more than one document.

4 Press the [Delete File] key.

A confirmation dialog box appears.

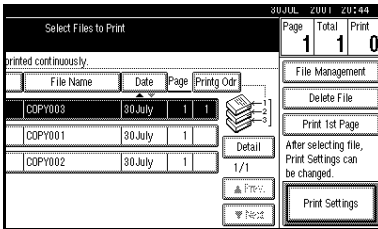

5 Press the [Delete] key to delete it.

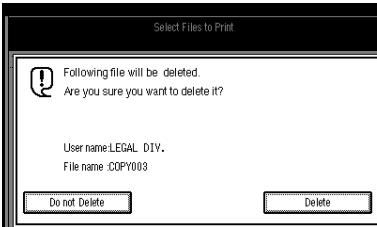

Note

- To cancel the delete operation, press the [Do not Delete] key.







3

4. Troubleshooting

If Your Machine Does Not Operate as You Want

General

Machine Status	Problem/Cause	Action
Please wait.	A message appears when you turn on the operation switch, or change the toner bottle.	Wait for the machine.
Cannot detect original size.	Improper original is set. ⇒ P.19 "Sizes difficult to detect".	Set custom size original on the exposure glass. ⇒ P.29 "Setting Originals on the Exposure Glass".
		Input the horizontal and vertical size of the custom original. ⇒ P.29 "Setting Originals on the Exposure Glass".
		Select paper manually, not in Auto Paper Select mode.
	Do not use Auto Reduce/Enlarge mode.	
Original is not set.	Set your originals.	
Check original orientation.	There is no copy paper that is in the same direction as the originals.	Set the original in the same direction as the copy paper.
Check paper size.	Improper paper size is set.	If you press the [Start] key, copy job starts.
Rotate Sort is not available with this image size.	The size of paper for which no rotate-sorting is available is selected.	Select the proper paper size. ⇒ P.43 "Sort".
Cannot punch paper of this size.	The Punch function cannot be used the paper size selected.	The following paper sizes are available for Punch mode: A3☐, B4☐, A4☐☐, B5☐☐, A5☐☐, 11×17☐, Legal(8 ¹ / ₂ ×14")☐. Select one of these sizes. ⇒ P.54 "Punch".
It is over stapling capacity.	The number of sheets per set is over the staple capacity.	Check the stapler capacity. ⇒ P.47 "Staple".

Machine Status	Problem/Cause	Action
Hole punch receptacle is full. Open the door as shown and empty receptacle.	Punch hole receptacle is full.	Check the punch waste box and remove punch waste. ⇒ P.200 “  Removing Punch Waste”.
Cannot staple paper of this size.	The Staple function cannot be used the paper size selected.	Select the proper paper size that can be used in Staple mode. ⇒ P.47 “Staple”.
Duplex is not available with this paper size.	A paper size not available in Duplex mode has been selected.	Select a paper size that can be used in Duplex mode. ⇒ P.82 “Duplex”.
Maximum number of sets is *.	The number of copies exceeds the maximum copy quantity.	The following paper sizes are available for Duplex mode: A3  , B4  , A4  , B5  , A5  . Select one of these sizes. ⇒ “Max. Copy Quantity” in P.209 “General Features ² / ₄ ”

Document Server

Machine Status	Problem/Cause	Action
Scanned pages exceeded max. number. Do you want to store the scanned pages as a file?	The number of scanned pages exceeds the capacity per file of the Document Server.	If you want to store the scanned originals as a file, press the [Store File] key. The originals are stored as a file in the Document Server. If you don't want any scanned originals to be stored, press the [Not to Store] key. The scanning data will be cleared.

Document Server



Problem	Action
You forgot your password.	<p>You can confirm your password.</p> <p>Press [Yes] key onto “Display Password with Stored file” temporarily, you can check the password when you selected the file. ⇒ “Display Password with Stored file” in system settings.</p> <p>Without the password, you cannot edit or print the document. Scan the document again.</p> <p>You can delete all the saved documents at once with the User Tools. ⇒ “Delete All The Saved Files” in P.226 “Input/Output”.</p> <p>Make sure that no important document is saved in the Document Server before deleting all of the saved documents.</p>
You cannot find out what is saved in a file.	<p>Check the date or time column in the “Document Server: Files” display.</p> <p>Check the contents of the document by printing the first page of it. Press the line for the desired document in the “Document Server: Files” display, and press the [Print 1st Page] key followed by the [Start] key.</p>
Memory becomes full frequently.	<p>Select the document that you want to delete, and then press the [Delete File] key. ⇒ P.162 “Deleting Saved Documents”.</p>
You want to check the print result before making a large print run.	<p>Check the print result by printing out only the first set. ⇒ P.159 “Sample Printing”.</p>
You want to save a document which cannot be deleted automatically.	<p>Turn “Auto File Delete” off, then save the document in the Document Server.</p> <p>If you turn “Auto File Delete” on after saving the document, this function is applied to the next saved documents.</p>

Display

Problem	Problem/Cause	Action
The display panel is off.	The screen contrast knob is turned to the dark position.	Set the screen contrast knob to the light position for proper viewing of the display panel.
	The machine is in Energy Saver mode.	Press the [Energy Saver] key to cancel Energy Saver mode.
	The operation switch is turned off.	Turn on the operation switch.
Nothing happens when the operation switch is turned on.	The main power switch is turned off.	Turn on the main power switch.

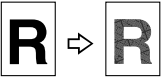

4

If You Cannot Make Clear Copies

Problem	Cause	Action
Copies appear dirty.	The image density is too dark.	Adjust the image density. ⇒ P.35 "Adjusting Copy Image Density".
	Auto Image Density is not selected.	Select Auto Image Density.
The reverse side of an original image is copied.	The image density is too dark.	Adjust the image density. ⇒ P.35 "Adjusting Copy Image Density".
	Auto Image Density is not selected.	Select Auto Image Density.
A shadow appears on copies if you use pasted originals.	The image density is too dark.	Adjust the image density. ⇒ P.35 "Adjusting Copy Image Density".
		Change the direction of the original.
		Put mending tape on the pasted part.
The same copy area is dirty whenever making copies.	The exposure glass or document feeder is dirty.	Clean them. ⇒ P.232 "Maintaining Your Machine".
Copies are too light.	The image density is too light.	Adjust the image density. ⇒ P.35 "Adjusting Copy Image Density".
	The paper size is not appropriate.	Use the recommended paper.  Note <input type="checkbox"/> Light copy may occur when you use damp or rough grain paper.
	Toner cartridge is almost empty.	Add toner. ⇒ P.178  "Adding Toner".
Parts of the image are not copied.	The original is not set correctly.	Set originals correctly. ⇒ P.29 "Setting Originals".
	An improper paper size is selected.	Select the proper paper size.
Copies are blank.	The original is not set correctly.	When using the exposure glass, face the originals down. When using the document feeder, face them up. ⇒ P.29 "Setting Originals".
A moiré pattern is produced on copies. 	Your original has a dot pattern image or many lines.	Place the original on the exposure glass at a slight angle.

If You Cannot Make Copies As You Want

General

Problem	Cause	Action
Copies are not stapled.	There are jammed staples in the stapler.	Remove jammed staples. ⇒ P.196 “  Removing Jammed Staples”.
		 Note <input type="checkbox"/> After removing jammed staples, staples might not be ejected the first few times you try to use the stapler.
	The number of copies exceeds the capacity of the stapler.	Check the stapler capacity. ⇒ P.47 “Staple”.
	Copy paper is curled.	Turn the copy paper over in the tray.
Staples are wrongly positioned.	Originals are not set correctly.	Place the original on the upper left corner of the exposure glass. ⇒ P.47 “Staple”.
Misfeeds occur frequently.	Copy paper size setting is not correct.	Set the proper paper size. ⇒ P.188 “Changing the Paper Size”.
You cannot combine several functions.	Selected functions cannot be used together.	⇒ P.143 “Combination Chart”.
When sorting, the pages are divided into two blocks.	The memory became full in the middle of sorting and the pages were ejected in two blocks.	You can interrupt the copying when the memory becomes full. ⇒ “Memory Full Auto Scan Restart” in P.226 “Input/Output”.

4

Adjust Image

Problem	Cause	Action
In Double Copies mode, parts of the original image are not copied.	Combination of original and copy paper is not correct.	Select A3 <input type="checkbox"/> for A4 originals <input type="checkbox"/> , A4 for A5 originals, and B5 for B6 originals. ⇒ P.110 "Double Copies".
In Border, Center, or Center/Border mode, parts of the original image are not copied.	You set the wide erased margin.	Change the margin width narrower. You can change it between 2-99mm. ⇒ "Erase Border Width" and "Erase Center Width" in P.216 "Edit 1/2". Set the originals correctly.
	Originals are not scanned correctly.	
In Margin Adjustment mode, parts of the original image are not copied.	You set the wide erased margin.	Set the narrow margin with the User Tools. ⇒ "Front Margin: Left/Right" and "Back Margin: Left/Right" in P.216 "Edit 1/2".
	There is a lock of margin space on the opposite side of the binding position.	
In Image Repeat mode, the original image is not copied repeatedly.	You selected the same size copy paper as originals, and did not select the proper reproduction ratio.	Select copy paper larger than the originals.
		Select the proper reproduction ratio.

Stamp



Problem	Cause	Action
The stamp position is wrong.	The paper orientation is wrong.	Check the paper orientation and stamp position.

Combine

Problem	Cause	Action
You cannot make a book from a booklet or magazine by folding copies.	Combine Original Booklet Format or Combine Original Magazine Format is not correct.	Change the setting. ⇒ P.85 "Combine".
Parts of the image are not copied.	You specified an improper reproduction ratio that does not meet the sizes of your originals and copy paper.	When you specify a reproduction ratio using Manual Paper Select mode, make sure that the ratio matches your originals and the copy paper. Note <input type="checkbox"/> Select the correct reproduction ratio before using Combine mode.
	When you use staple and punch together, extra margin may appear.	Sometimes stapling and the punch hole may not work well together. In this case, change the direction of the originals.
Order of copies is not correct.	You set originals in the incorrect order.	When setting a stack of originals in the document feeder, the last page should be on the bottom.
		If you set an original on the exposure glass, start with the first page to be copied.

4

Duplex

Problem	Cause	Action
Order of copies is not correct.	You set originals in the incorrect order.	<p>When setting a stack of originals in the document feeder, the last page should be on the bottom.</p> <p>If you set an original on the exposure glass, start with the first page to be copied.</p>
Orientation of copies (Top to Top, or Top to Bottom) is not correct.	You set originals in an incorrect direction or the orientation setting is incorrect.	<p>Select the correct orientation, or set originals correctly. ⇒ P.82 "Duplex".</p> <p> Note</p> <p><input type="checkbox"/> If you set A3, 11" × 17" or B4, 8¹/₂" × 14" originals as shown below, select [Top to Bottom] to make copies in "Top to Top" orientation. Or select [Top to Top] to make copies in "Top to Bottom" orientation.</p> <div style="display: flex; justify-content: space-around; align-items: center;">   </div> <p style="text-align: right; font-size: small;">CP270-A</p>

When Memory Is Full

! Limitation

- If memory is full on either the master unit or sub-unit, Interrupt Copy will not be available.

✎ Note

- If you set “Memory Full Auto Scan Restart” of the User Tools to “Yes”, the memory overflow message will not be displayed, but make Connect Copy for the scanned original automatically. Connect Copy continues scanning and copying until finishing the job. Note that copy sets will be printed out separately by scanning at this time.

Machine Status	Action
Memory is full.	Press the [Output] key to copy scanned originals and clear the scanning data. Press the [Clear] key to clear the scanning data and not copy.
Press [Resume] to scan and copy remaining originals.	To continue copying, remove all copies then press the [Resume] key. To stop copying, press the [Stop] key.

Document Server

Machine Status	Action
Memory is full.	Delete any unnecessary files and then scan the document again. ⇒ P.162 “Deleting Saved Documents”.

☰ Loading Paper

📌 Note

- ☐ If you want to change the paper size of tray 1-2 ⇒ P.188 “Changing the Paper Size”.

🔍 Reference

Regarding paper types and sizes, ⇒ P.21 “Copy Paper”.

Loading Paper in Tray 1 or 2

- 1 Pull out the paper tray until it stops.

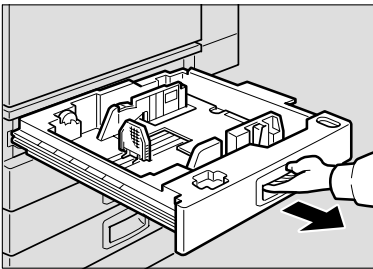

ZDSY100J

- 2 Remove the back fence.

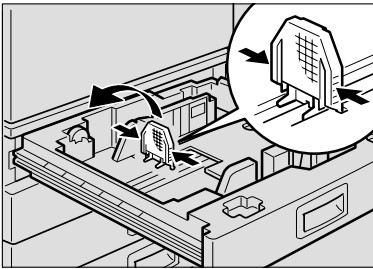

ZDSY200J

- 3 Square the paper and set it in the tray.

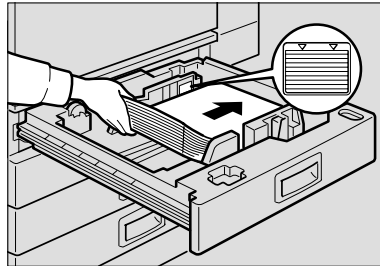

ZDSY210J

⚠ Important

- ☐ Do not stack paper over the limit mark.
- ☐ Make sure that the paper stack is flush with the right side fence.

📌 Note

- ☐ Shuffle the paper before setting it in the tray.
- ☐ Straighten the paper, if curled or warped, before placing it in the tray.

- 4 Set the back fence.

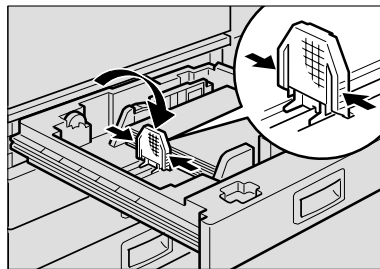

ZDSY220J

- 5** Push the paper tray in until it stops.

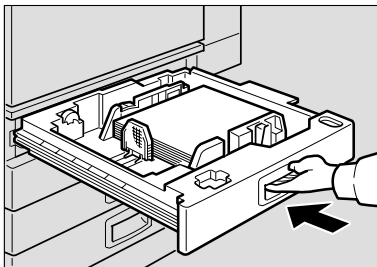

ZDSY120J

Important

- Do not stack paper over the limit mark.
- Make sure that the paper stack is flush with the right side fence.

Note

- Shuffle the paper before setting it in the tray.
- Straighten the paper, if curled or warped, before placing it in the tray.

4

Loading Paper in Tray 3 or 4

- 1** Pull out the paper tray until it stops.

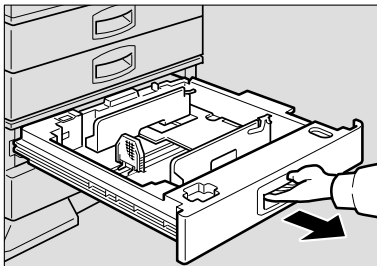

ZDSY340J

- 3** Square the paper and set it in the tray.

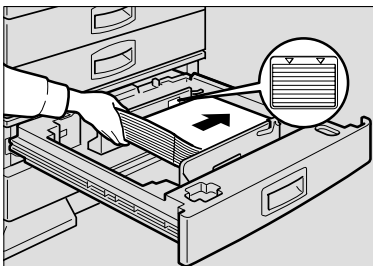

ZDSY260J

- 2** Remove the back fence.

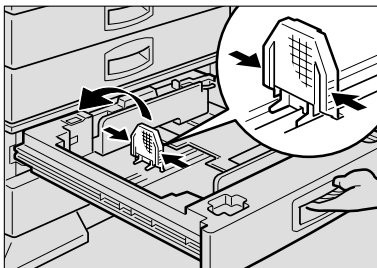

ZDSY240J

- 4** Set the back fence.

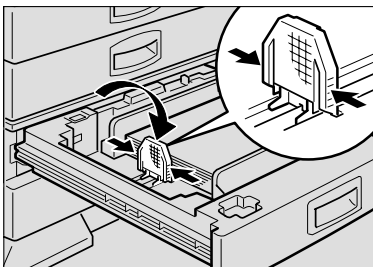

ZDSY260J

Loading Paper in the Large Capacity Tray

- 1** Press the key if it is not lit.

The key blinks while the bottom plate is moving down.

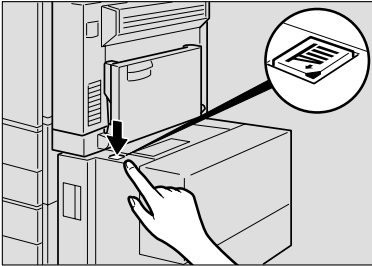

- 2** When the key stops blinking and lights up, open the top cover.

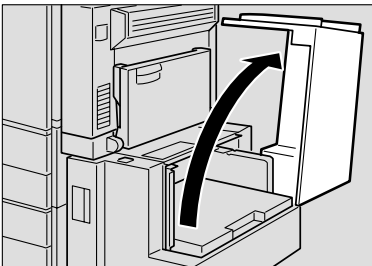

Note

- Make sure no paper sheet is involved in the feeding paper of the Large Capacity Tray, Remove the sheet, if any.

- 3** Place the paper in the tray along the edge on the left.

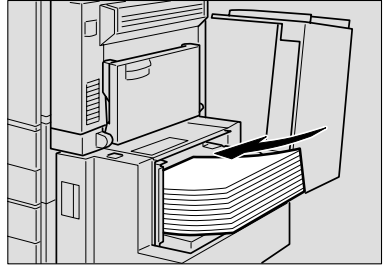

Note

- The Tray contains up to 1,500 sheets.

Important

- Do not stack paper over the limit mark.
- Make sure that the paper stack is flush with the right side fence.

- 4** Close the top cover.

Adding Toner

When  is displayed, it is time to supply toner.

WARNING:

- **Do not incinerate used toner or toner containers. Toner dust might ignite when exposed to an open flame. Dispose of used toner containers in accordance with local regulations for plastics.**

CAUTION:

- *Keep toner (used or unused) and toner containers out of reach of children.*

CAUTION:

- *Our products are engineered to meet high standards of quality and functionality, and we recommend that you only use the expendable supplies available at an authorized dealer.*

Important

- If you use toner other than that recommended, an error might occur.
- When adding toner, do not turn off the operation switch. If you do, your settings are cleared and  will appear again because the machine will not recognize that toner has been added.
- Always add toner after the machine instructs you to add toner.
- Do not use used toner. This will damage the machine.

Note

- You can still make about 90 copies after  appears, but replace the toner early to prevent poor copy quality.

Reference

Regarding toner storage, ⇒ P.26 “Toner Storage”.

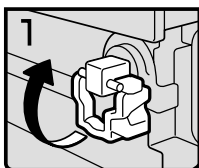

Toner1

- 1: Open the front cover of the machine.
- 2: Lift the green lever.

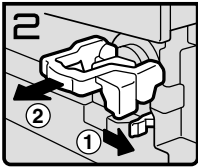

Toner2

- 3: Push the green lever, and then gently pull out the holder.

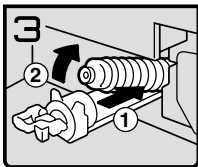

Toner3

- 4: Press the toner bottle backward to raise its head, and then gently pull out the bottle.

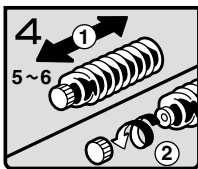

Toner4

- 5: Hold a new bottle horizontally and shake it 5 or 6 times.

Note

- Do not remove the black cap when shaking.

- 6: Remove the black cap.

Note

- Do not remove the inner cap.

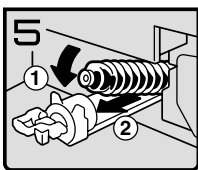

Toner5

- 7: Put the toner bottle on the holder, and then press its head forward.

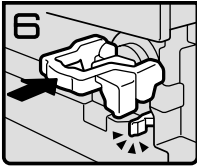

Tone#6

- 8: Push the holder until it clicks.
- 9: Push down the green lever.
- 10: Close the front cover of the machine.

Clearing Misfeeds

CAUTION:

- *The fusing section of this equipment might be very hot. You should be very careful that you don't touch this section when removing the misfed paper.*

Important

- When clearing misfeeds, do not turn off the operation switch. If you do, your copy settings are cleared.
- To prevent misfeeds, do not leave any torn scraps of paper within the machine.
- If paper misfeeds occur repeatedly, contact your service representative.

Note

- More than one misfed area may be indicated. In this case, check every applicable area. See the following charts: A, B, C, D, E, P, U, R, Y, Z
- You can find a sticker explaining how to remove misfed paper inside of the front cover or inside of the finisher.

■ When D is lit

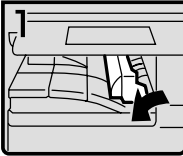

1. Open the right cover of the interchange unit to the left.

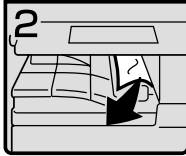

2. Remove misfed paper.
3. Close the cover.

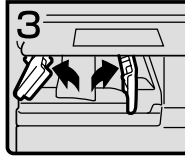

4. If you cannot remove misfed paper, open the bottom covers of the interchange unit.

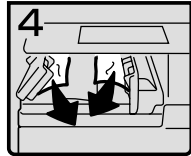

5. Remove misfed paper.
6. Close the covers.

4

■ When B is lit

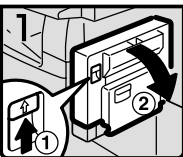

1. Open the duplex unit.

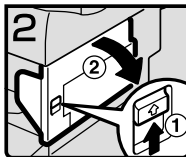

2. Push up the lever and open the cover.

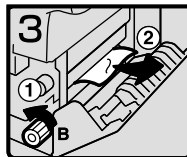

3. Open the front cover of the main frame.

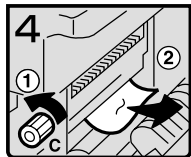

4. Turn knob B counterclockwise and remove misfed paper.
5. Turn knob C counterclockwise and remove misfed paper.
6. Close the duplex unit.

■ When A is lit

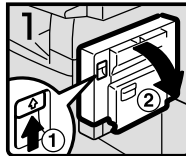

1. Open the duplex unit.

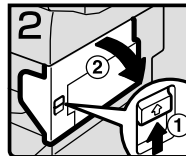

2. Push up the lever and open the cover.

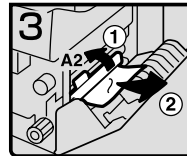

3. Push handle A2 to the left and remove misfed paper.

When E is lit

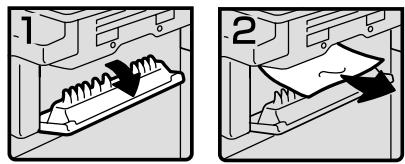

1. Open the cover.
2. Remove misfed paper.
3. Close the cover.

When C is lit

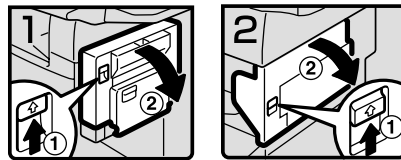

1. Open the duplex unit.
2. Push up the lever and open the cover.

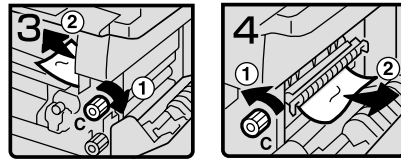

3. Open the front cover.
4. Turn knob C clockwise or counterclockwise and remove misfed paper.
5. Close the cover.
6. Close the duplex unit and front cover.

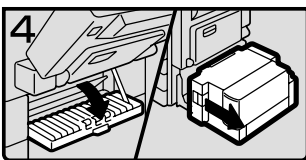
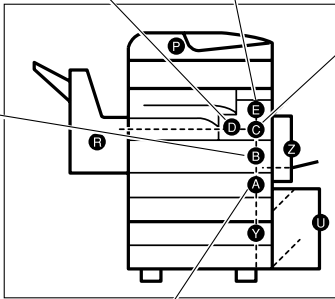

4. If you cannot remove misfed paper, open the cover.
If your machine is equipped with the large capacity tray, slide it to the right.

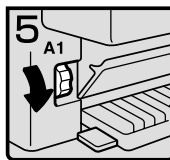

5. Turn knob A1 downward.

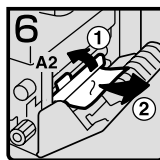

6. Push handle A2 to the left and remove misfed paper.

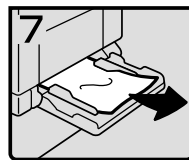

7. Open the bypass tray and remove misfed paper.

You can make an enlarged copy of this page and stick it on wall.

■ When R is lit

2 Tray finisher

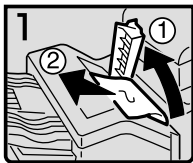

1. Open the upper cover.
2. Remove misfed paper.

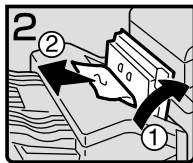

3. If you cannot remove misfed paper, open the side cover and remove misfed paper.

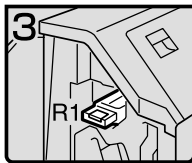

4. Open the front cover.

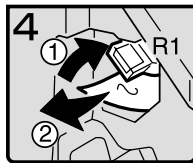

5. Hold up lever R1 and remove misfed paper.

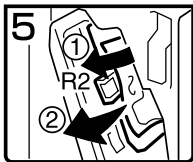

6. Hold down lever R2 and remove misfed paper.

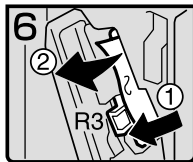

7. If you cannot remove misfed paper, hold down lever R3 and remove misfed paper.

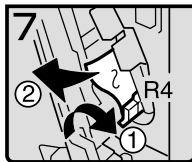

8. Hold down lever R4 and remove misfed paper.

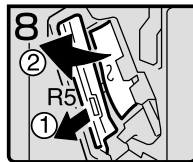

9. Pull lever R5 and remove misfed paper.
10. Close the front cover.

1000-sheet finisher

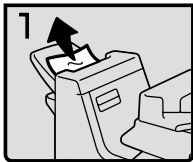

1. Remove misfed paper.

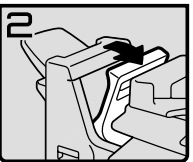

2. If you cannot remove misfed paper, open the top cover.

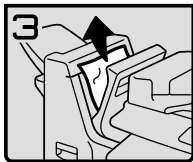

3. Remove misfed paper.

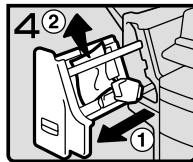

4. If you cannot remove misfed paper, pull out the front cover and remove misfed paper.

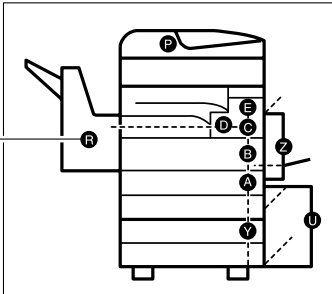

■ When P is Lit

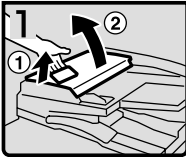

1. Lift the lever ① and open the upper cover ②.

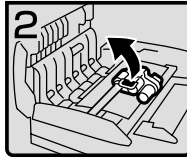

2. Lift the lever.

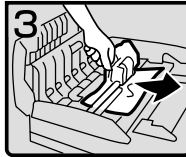

3. Remove misfed original.

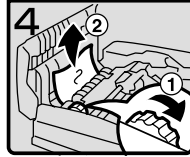

4. If you cannot remove the misfed original, turn the dial ① clockwise and remove the misfed original ②.

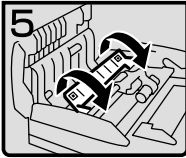

5. Open the cover.

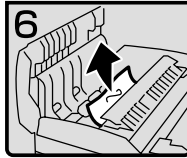

6. Remove the misfed original and close the cover.

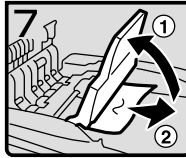

7. If you cannot remove the misfed original, hold up the tray and remove the original.

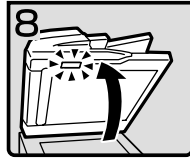

8. Close the upper cover. 9. Lift the document feeder and check the sticker.

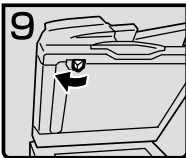

10. Slide blue lever to the left.

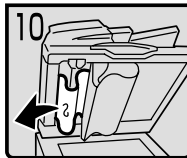

11. Pull the cover and remove the misfed original.

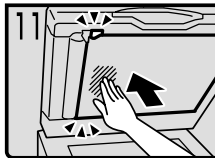

12. Push center of the cover and close until it clicks.

■ When Y is Lit



1. Open the right cover of the paper tray unit. If your machine is equipped with the large capacity tray, slide it to the right and open the right cover of the paper tray unit.

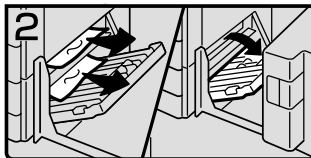

2. Remove misfed paper.

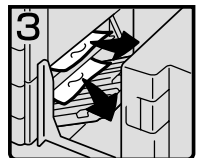

3. Close the right cover of the paper tray unit. If your machine is equipped with the large capacity tray, set it back.

When Z is Lit

1. Open the side cover of duplex unit and remove misfed paper.
2. If you cannot remove misfed paper, open the duplex unit.
3. If you cannot find misfed paper, open cover Z and remove misfed paper.
4. Close the duplex unit.

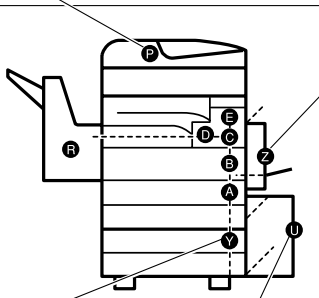

4

When U is Lit

1. Slide the large capacity tray to the right.
2. Open the top cover of the large capacity tray.
3. Remove misfed paper.
4. If you cannot remove the misfed paper, try to remove the misfed paper from the left side of the large capacity tray.
5. Close the top cover and return the Large Capacity Tray (LCT).

You can make an enlarged copy of this page and stick it on wall.

Changing the Paper Size

Important

- ❑ If you wish to change the paper size set in the optional large capacity tray (LCT), contact your service representative.
- ❑ Be sure to select paper size with the user tools. Otherwise, misfeeds might occur.

Reference

For paper sizes, weight, and capacity that can be set in each tray, ⇒ P.21 "Copy Paper".

Changing the Paper Size in Tray 1 or 2

- 1 Make sure that the paper tray (tray 1 or 2) is not being used. Then fully pull out the tray.

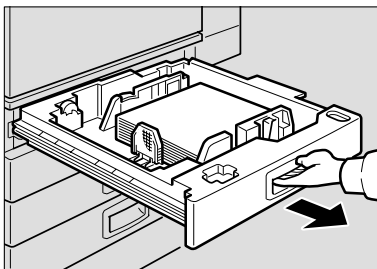

ZDSY130J

- 2 Remove the back fence.

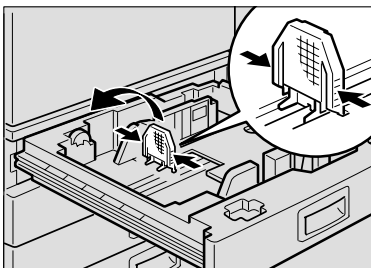

ZDSY200J

- 3 Remove any remaining copy paper.

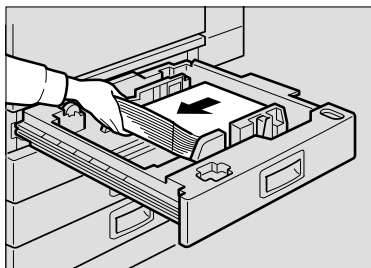

ZDSY140J

- 4 Release the side lever.

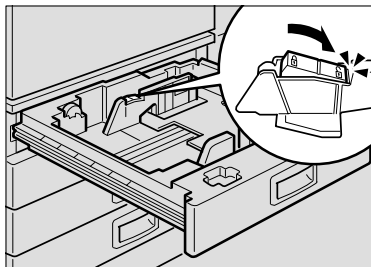

ZDSY150J

- 5** While pressing the release lever, adjust the side fences.

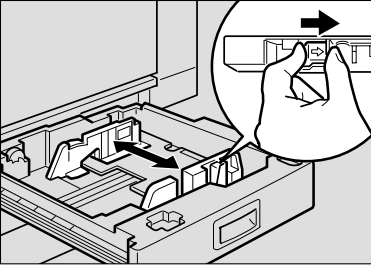

ZDSY160J

- 6** Square the paper and load it into the tray.

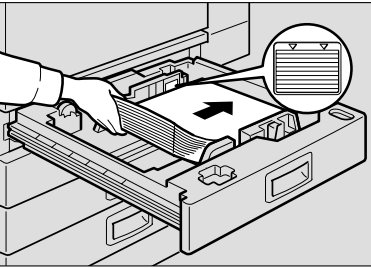

ZDSY110J

Important

- Do not stack paper over the limit mark.
- Make sure that the paper stack is flused with the right side fence.

Note

- Shuffle the paper before setting it in the tray.
- Make sure the leading corners of the paper are under the corners.
- Straighten the paper, if curled or warped, before placing it in the tray.

- 7** Lock the side lever.

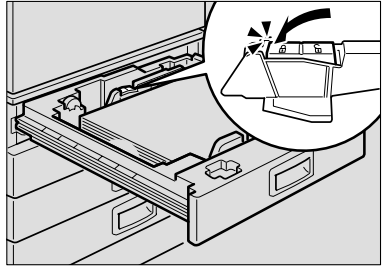

ZDSY230J

- 8** Adjust the back fence to the new paper size.

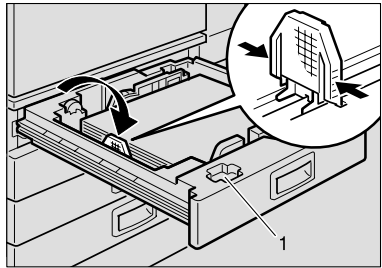

ZDSY170J

Note

- For 11" × 17" paper, put the back fence inside 1.

- 9** Adjust the tray size with the paper size selector to the new paper size.

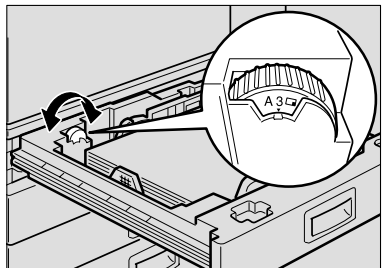

ZDSY180J

To adjust the paper size to one not available with the paper size selector

- ❶ Set the paper size selector to the ✖ mark on the left.
- ❷ Press the [User Tools/Counter] key.
- ❸ Press the [System Settings] key.
- ❹ Press the [Paper Size Setting] key.
- ❺ Press the [Tray Paper Size: Tray 1] or the [Tray Paper Size: Tray 2] key.
- ❻ Select your desired size. Then, press the [OK] key.
- ❼ Press the [Exit] key or press the [User Tools/Counter] key to exit the User Tools.

Important

- Be sure to select the paper size with the User Tools (System Settings). Otherwise, misfeeds might occur.

Reference

For details, ⇒ “User Tools (System Settings)” in the System Settings manual.

- ❿ Gently push the paper tray in until it stops.

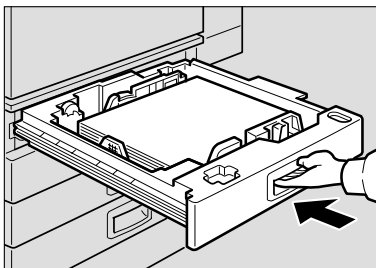

ZDSY190J

- ⓫ Check the paper size displayed on the display panel.

Changing the Paper Size in Tray 3 or 4

- ❶ Make sure that the paper tray is not being used.
- ❷ Pull the paper tray out, and then lift and remove it.

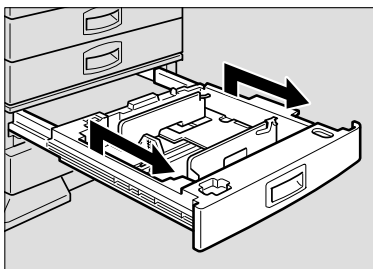

ZDSY280J

Note

- Remove any remaining copy paper.

- ❸ Remove the screws fastening the side fences using the screwdriver.

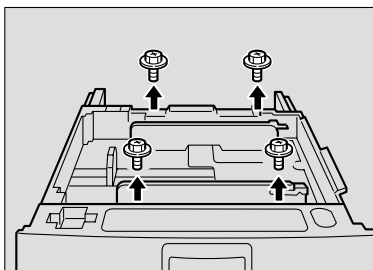

ZDSY290J

Note

- A screwdriver is contained in the front area of the top tray.

- 4** Re-position the side fences to the paper size you want to use.

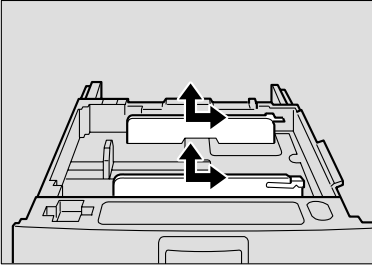

ZDSY300J

- 5** Fasten the fences with screws.

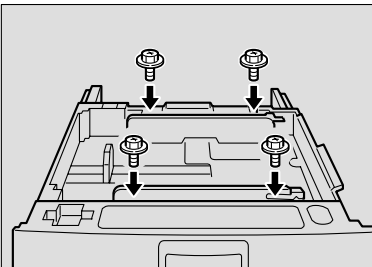

ZDSY310J

- 6** Square the paper and load it into the tray.

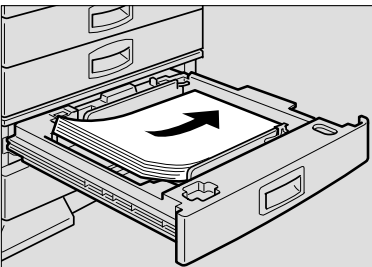

ZDSY320J

Important

- Do not stack paper over the limit mark.

Note

- Shuffle the paper before setting it in the tray.
- Make sure the leading corners of the paper are under the corners.

- 7** Adjust the back fence to the new paper size.

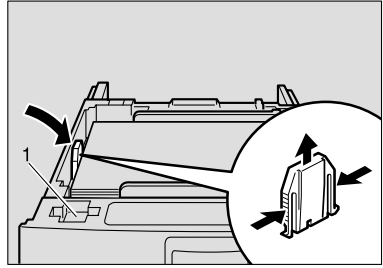

ZDSY330J

Note

- For 11" × 17" paper, put the back fence inside 1.

- 8** Push the paper tray in until it stops.

- 9** Select the paper size with the user tools.

Adding Staples

CAUTION:

- *Our products are engineered to meet high standards of quality and functionality, and we recommend that you only use the expendable supplies available at an authorized dealer.*

Important

- If you use a staple cartridge other than that recommended, staple failure or staple jams might occur.

1000-Sheet Finisher

4

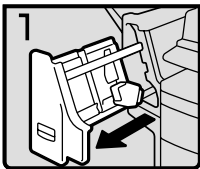

fin101EE

- 1: Open the front cover.

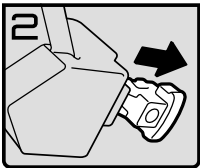

fin102EE

- 2: Remove the cartridge.

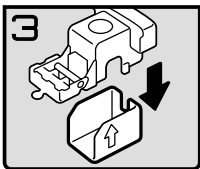

fin103EE

- 3: Take out the empty refill in the arrow direction.

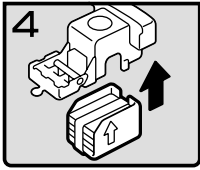

f1n104EE

- 4: Push in the new refill until it clicks.

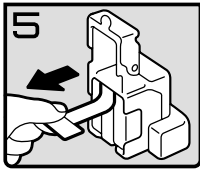

f1n105EE

- 5: Pull out the ribbon.

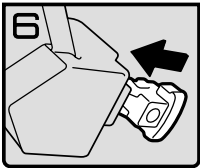

f1n106EE

- 6: Reinstall the cartridge.

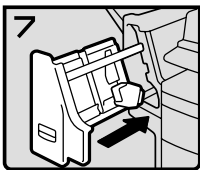

f1n107EE

- 7: Close the front cover.

2 Tray Finisher



ZCAJ031E

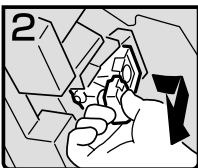

ZCAJ040E

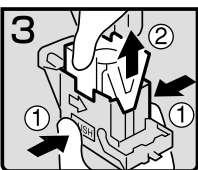

ZCAJ050E

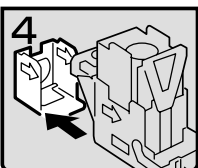

ZCAJ060E

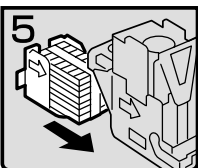

ZCAJ070E

- 1: Open the front cover of the finisher.

- 2: Hold the green lever and pull out the cartridge gently.

- 3: Hold the both sides of the cartridge.
- 4: Pull up the upper unit of the cartridge.

- 5: Take out the empty refill in the arrow direction.

- 6: Align the arrows on the new refill and the cartridge, and then push in the refill until it clicks.

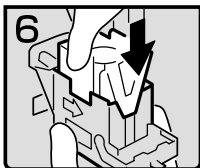

ZCAJ080E

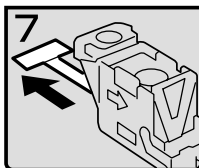

ZCAJ090E

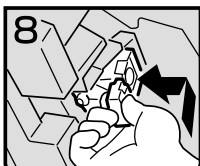

ZCAJ100E

- 7: Hold down the upper unit to the cartridge gently.

- 8: Pull out the ribbon.

- 9: Hold the green lever and reinstall the cartridge until it clicks.
- 10: Close the front cover of the finisher.

Removing Jammed Staples

Note

- Staples might be jammed because of curled copies. In this case, try turning the copy paper over in the tray. If there is no improvement, change the copy paper with less curls.
- After removing jammed staples, staples might not be ejected the first few times you try to use the stapler.

1000-Sheet Finisher

4

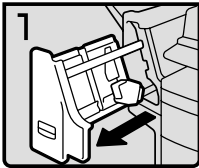

fin10BEE

- 1: Open the front cover.

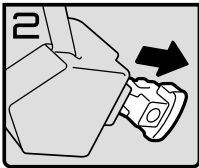

fin10BEE

- 2: Remove the cartridge.

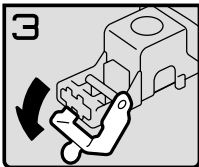

fin110EE

- 3: Open the face plate.

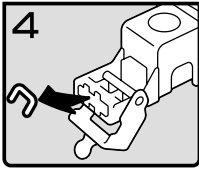

fn111EE

- 4: Remove the jammed staples.

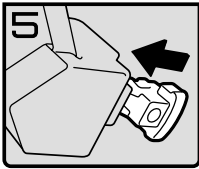

fn112EE

- 5: Reinstall the cartridge.

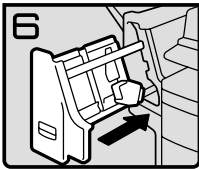

fn113EE

- 6: Close the front cover.

2 Tray Finisher

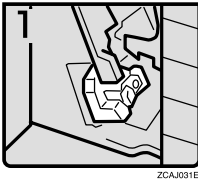

- 1: Open the front cover of the finisher.

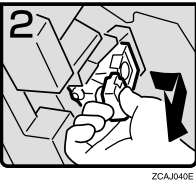

- 2: Hold the green lever and pull out the cartridge gently.

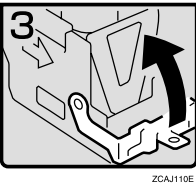

- 3: Pull up the knob of the cartridge.

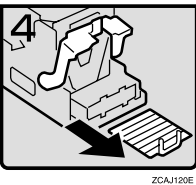

- 4: Take out all staples slid from the cartridge.

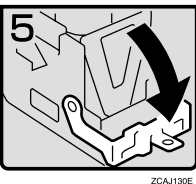

- 5: Pull down the knob of the cartridge until it clicks.

4

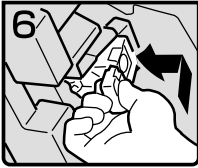

ZCAJ140E

- 6: Hold the green lever and reinstall the cartridge until it clicks.
- 7: Close the front cover of the finisher.

Removing Punch Waste

Note

- While “Hole punch receptacle is full.” is displayed, you cannot use the Punch function.

- 1** Open the front cover of the 2 Tray finisher.

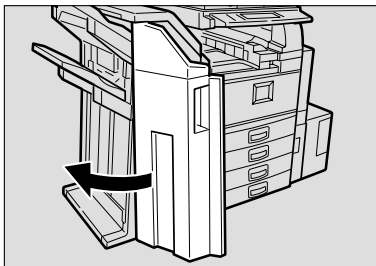

ZDS0010J

- 2** Pull out the punch waste box and remove punch waste.

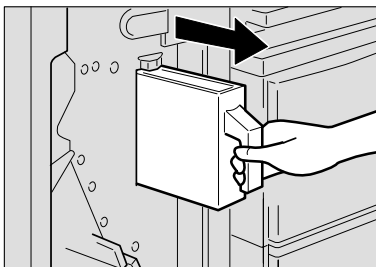

ZDS0020J

- 3** Reinstall the punch waste box.

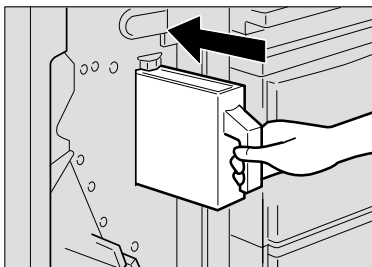

ZDS0030J

Note

- If you do not, “Hole punch receptacle is full.” is still displayed.

- 4** Close the front cover of the 2 Tray finisher.

“Hole Punch Receptacle Full.” disappears.

Note

- If the message is still displayed, reinstall the punch waste box.

5. User Tools (Copy/Document Server Features)

Accessing the User Tools (Copy/Document Server Features)

This section is for the key operators in charge of this machine. You can change or set the machine's default settings.

Preparation

After using the User Tools, be sure to exit from the User Tools.

The selected key is highlighted.

Any changes you make with the User Tools remain in effect even if the main power switch or operation switch is turned off, or the **[Clear Modes]** key is pressed.

Reference

For details, ⇒ “Accessing the User Tools (System Settings)” in the System Settings manual.

1 Press the **[User Tools/Counter]** key.

The User Tools Main Menu appears.

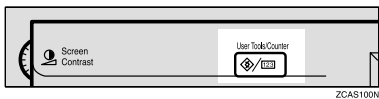

2 Press the **[Copier/Document Server Features]** key.

The Copier/Document Server Features menu appears.

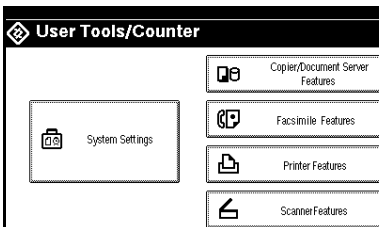

3 Select the desired menu and press the key.

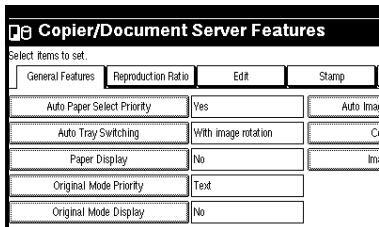

Note

- [▼Next]**: Press to go to the next page.
- [▲Previous]**: Press to go back to the previous page.

Reference

⇒ P.204 “User Tools Menu (Copier/Document Server Features)”.

4 Change the settings by following the instructions on the display panel. Then press the **[OK]** key.

Reference

⇒ P.212 “General Features $\frac{4}{4}$ ”.

Note

- [OK]**: Press to set the new settings and return to the previous menu.
- [Cancel]**: Press to return to the previous menu without changing any data.

Exiting From the User Tools

- 1 After changing the User Tools settings, press the [Exit] key on the User Tools Main Menu.

Changing the User Tools is completed, and the machine is ready for copying.

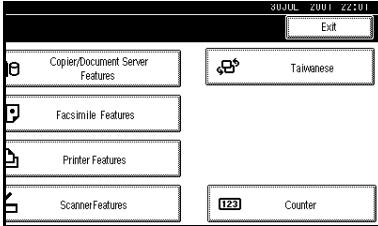

Note

- ❑ To exit from the change of the machine's default settings and return to Copy mode, press the [User Tools/Counter] key.
- ❑ You can also exit from the User Tools by pressing the [User Tools/Counter] key.

User Tools Menu (Copier/Document Server Features)

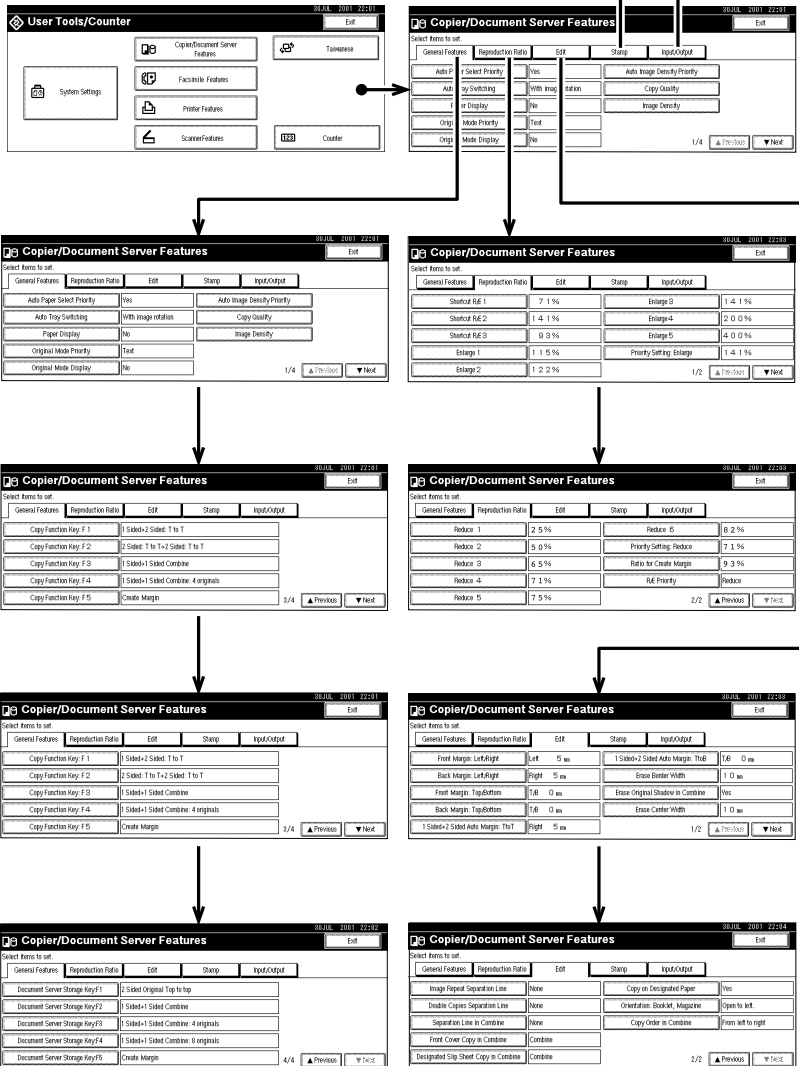

5

08JUL 2001 22:20

Copier/Document Server Features [Exit]

Select items to set:

General Features Reproduction Rate Edit Stamp Input/Output

Background Numbering Proof Stamp User Stamp Date Stamp Page Numbering

Size Normal

Density Normal

08JUL 2001 22:20

Copier/Document Server Features [Exit]

Select items to set:

General Features Reproduction Rate Edit Stamp Input/Output

Background Numbering Proof Stamp User Stamp Date Stamp Page Numbering

Stamp Format P1_P2 --- Page Numbering in Corner Per original

Font Font 1 Stamp on Designated Slip Sheet No

Size Auto Stamp Position P1_P2 --- Top right

Overlap Back Page Stamping Position Opposite position 1/2 [A 176-3267] [▼] [Help]

08JUL 2001 14:20

Copier/Document Server Features [Exit]

08JUL 2001 14:20

Copier/Document Server Features [Exit]

08JUL 2001 14:20

Copier/Document Server Features [Exit]

08JUL 2001 14:20

Copier/Document Server Features [Exit]

Select items to set:

General Features Reproduction Rate Edit Stamp Input/Output

Background Numbering Proof Stamp User Stamp Date Stamp Page Numbering

Size Normal

Density Normal

08JUL 2001 22:20

Copier/Document Server Features [Exit]

Select items to set:

General Features Reproduction Rate Edit Stamp Input/Output

Switch to Switch (SAZF) Switch (SAZF) Select Switch Function Stack

SAZF Auto-Peak 5 seconds Select Stamping Position Top 2

Reduce Cost: Auto-Paper Consume No

Auto Set No Lethaloid Setting No

Memory Full Auto Scale Restart No

08JUL 2001 22:20

Copier/Document Server Features [Exit]

08JUL 2001 22:20

Copier/Document Server Features [Exit]

Select items to set:

General Features Reproduction Rate Edit Stamp Input/Output

Background Numbering Proof Stamp User Stamp Date Stamp Page Numbering

Program/Date Stamp Stamp Position 4 #/hr promz Top right

Stamp Position: 1 #/hr promz Top right Stamp Format: 1 #/hr promz All pages

Stamp Position: 2 #/hr promz Top right Stamp Format: 2 #/hr promz All pages

Stamp Position: 3 #/hr promz Top right

1/2 [A 176-3267] [▼] [Help]

08JUL 2001 22:20

Copier/Document Server Features [Exit]

Select items to set:

General Features Reproduction Rate Edit Stamp Input/Output

Background Numbering Proof Stamp User Stamp Date Stamp Page Numbering

Format DYNAMIC Size Auto

Font Font 1 Superimpose No

Stamp Position Top left

Stamp Setting All pages

General Features ¹/₄

❖ Auto Paper Select Priority

As a default setting, Auto Paper Select is selected. You can cancel this setting.

Note

- Default: *Yes*

❖ Auto Tray Switching

If you load paper of the same size in two or more trays, the machine automatically shifts to another tray when the tray in use runs out of paper (when Auto Paper Select is selected.) This function is called “Auto Tray Switching”. This setting specifies whether to use “Auto Tray Switching” or not.

Default: *With image rotation*

Note

- [With image rotation]** Use this when copying with Auto Tray Switching.
- [Without image rotation]** Only copies with Auto Tray Switching if you load paper of the same size and in the same direction in two or more trays. If the paper is not the same size or in the same direction, the message “Load paper.” is displayed.
- [OFF]** When a paper tray runs out of paper, copying is interrupted and the message “Load paper.” is displayed.

❖ Paper Display

You can choose whether the available paper trays/sizes are shown on the initial display at Auto Paper Select mode.

Note

- Default: *Display*
- If you choose “Hide”, the display is shown as below. When the **[Auto Paper Select]** key is pressed, paper sizes appear on the display.

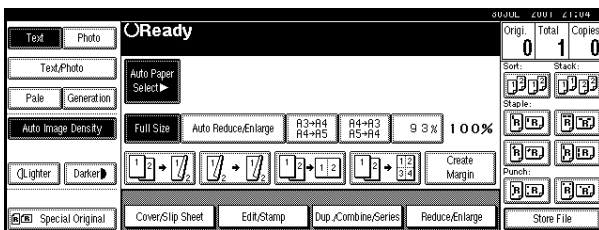

❖ Original Mode Priority

As a default setting, Text is selected as the Originals Type. You can change it to Text/Photo, Photo, Pale, or Generation Copy.

Note

- Default: *Text*

❖ Original Mode Display

You can choose whether the original modes are shown on the initial display.

📎 Note

- Default: *Display*
- If you choose “Hide”, the display is shown as below.

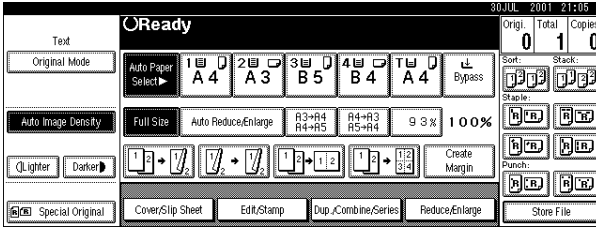

❖ Auto Image Density Priority

You can turn the Auto Image Density on or off for each of the original types (Text, Text/Photo, Photo, Pale, and Generation Copy).

📎 Note

- Default: *Text: On, Text/Photo: On, Photo: Off, Pale: On, Generation Copy: On*

❖ Copy Quality

You can adjust the quality level of copies for each of the original types (Text, Text/Photo, Photo, Pale, Generation Copy).

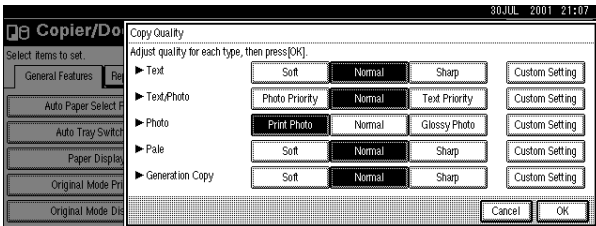

- Text
Adjust the sharpness of text.

📎 Note

- Default: *Normal*
- [Custom Setting]** is the value set during service setup.
- Choosing **[Sharp]** or **[Sort]** affects the outline sharpness of text.

- Text/Photo
When there are photo(s) and text on the original, determine whether the photo or text takes priority.

 **Note**

- Default: *Normal*
- [Custom Setting]** is the value set during service setup.
- [Normal]** achieves a good balance between text and photos.

- Photo
For a photo original, adjust the finish quality level to match the type of photo original.

 **Note**

- Default: *Print Photo*
- [Custom Setting]** is the value set during service setup.
- Select **[Print Photo]** for printed photo originals, and **[Glossy Photo]** for printed photo originals with fine dots.
- Select **[Normal]** for printed photo and text originals.

- Pale
Adjust the quality level for the finish of a pale original with normal density.

 **Note**

- Default: *Normal*
- [Custom Setting]** is the value set during service setup.

- Generation Copy
Adjust the quality level so as not to thicken the lines of the finish image.

 **Note**

- Default: *Normal*
- [Custom Setting]** is the value set during service setup.

❖ Image Density

You can select one of seven original image density levels for each of the original types (Text, Text/Photo, Photo, Pale, Generation Copy).

 **Note**

- Default: *Text: Normal, Text/Photo: Normal, Photo: Normal, Pale: Normal, Generation Copy: Normal*

General Features 2/4

❖ Duplex Mode Priority

You can select the type of the Duplex function effective when the machine is turned on, Energy Saver mode is off, or Auto Reset is on.

Note

Default:

- Metric version: *1 Sided*→*1 Sided*
- Inch version: *1 Sided*→*2 Sided*

❖ Copy Orientation in Duplex Mode

You can set the copy orientation when making two-sided copies.

Note

Default: *Top to Top*

❖ Original Orientation in Duplex Mode

You can set the original orientation when making two-sided copies.

Note

Default: *Top to Top*

❖ Change Initial Mode

You can select the initial mode or Program No. 10 as the mode effective when the machine is turned on, or modes are cleared.

Note

Default: *Standard*

❖ Max. Copy Quantity

The maximum copy quantity can be set between 1 and 999.

Note

Default: *999Sheets.*

❖ Tone: Original remains

The beeper (key tone) sounds when you forgot to remove originals after copying.

Note

Default: *On*

If the "Panel Tone" of the User Tools (System Settings) setting is "Off", the beeper does not sound irrespective of the "Tone: Original on Platen" setting. "Panel Tone" in the System Settings manual.

❖ **Job End Call**

You can choose whether or not the beeper sounds when copying is complete. If the "Panel Tone" of the User Tools (System Settings) settings is "Off", the machine beeps to notify you that the machine did not complete a job for reasons such as copying was interrupted, the paper tray ran out of paper or a paper jam occurred.

 **Note**

Default: *On*

General Features ³/₄

❖ Copy Function Key: F1-F5

You can register frequently used functions in Function Keys F1 to F5.

Note

Default:

- Copy Function Key: F1: *1 Sided*→*2 Sided:T to T*
- Copy Function Key: F2: *2 Sided:T to T*→*2 Sided:T to T*
- Copy Function Key: F3: *1 Sided*→*1 Sided Combine:2 Originals*
- Copy Function Key: F4: *1 Sided*→*1 Sided Combine:4 Originals*
- Copy Function Key: F5: *Create Margin*

General Features 4/4

❖ Document Server Storage Key: F1–F5

You can register frequently used functions in Function keys F1 to F5. You can also change the registered functions.

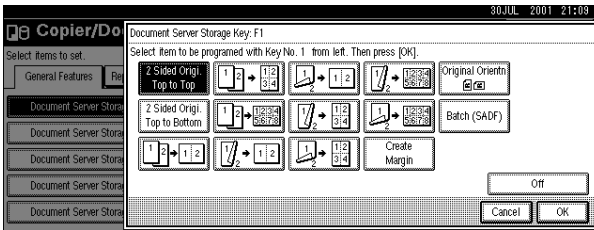

Note

Default

- Document Server Storage Key: F1: *2 Sided Original Top to Top*
- Document Server Storage Key: F2: *1 Sided → 1 Sided Combine*
- Document Server Storage Key: F3: *1 Sided → 1 Sided Combine: 4 originals*
- Document Server Storage Key: F4: *1 Sided → 1 Sided Combine: 8 originals*
- Document Server Storage Key: F5: *Create Margin*

Reproduction Ratio 1/2

❖ Shortcut R/E

You can register up to three frequently used Reduce/Enlarge ratios other than the fixed Reduce/Enlarge ratio and have them shown on the initial display. You can also change the registered Reduce/Enlarge ratios.

If no Reduce/Enlarge ratio has been set when selecting **[Shortcut R/E 1]**, **[Shortcut R/E 2]**, or **[Shortcut R/E 3]**, enter the desired Reduce/Enlarge ratio using the number keys.

❖ Enlarge 1-5

You can customize the enlargement ratios available when you press the **[Reduce/Enlarge]** key followed by the **[Enlarge]** key.

Note

Default:

- Metric version:
 - Enlarge 1: 115%
 - Enlarge 2: 122%
 - Enlarge 3: 141%
 - Enlarge 4: 200%
 - Enlarge 5: 400%
- Inch version:
 - Enlarge 1: 121%
 - Enlarge 2: 129%
 - Enlarge 3: 155%
 - Enlarge 4: 200%
 - Enlarge 5: 400%

When selecting **[User Enlrg. Ratio]**, enter a ratio using the number keys (in the range of 101 to 400%).

❖ Priority Setting: Enlarge

You can set the ratio with priority when the **[Reduce/Enlarge]** key is pressed, followed by the **[Enlarge]** key.

Note

Default:

- Metric version: 141%
- Inch version: 155%

Reproduction Ratio ²/₂

❖ Reduce 1-6

You can customize the reduction ratios available when you press the **[Reduce/Enlarge]** key followed by the **[Reduce]** key.

Note

Default:

- Metric version:
 - Reduce 1: 25%
 - Reduce 2: 50%
 - Reduce 3: 65%
 - Reduce 4: 71%
 - Reduce 5: 75%
 - Reduce 6: 82%
- Inch version:
 - Reduce 1: 25%
 - Reduce 2: 50%
 - Reduce 3: 65%
 - Reduce 4: 73%
 - Reduce 5: 78%
 - Reduce 6: 85%

When selecting **[User Redc.Ratio]**, enter a ratio using the number keys (in the range of 25 to 99%).

❖ Priority Setting: Reduce

You can set the ratio with priority when the **[Reduce/Enlarge]** key is pressed, followed by the **[Reduce]** key.

Note

Default:

- Metric version: 71%
- Inch version: 73%

❖ Ratio for Create Margin

You can set a Reduce/Enlarge ratio when registering “Create Margin” in a Shortcut Key.

Note

Default: 93%

◆ R/E Priority

Specify which Reduce, Enlarge or Input Ratio is shown on the display panel with priority when the **[Reduce/Enlarge]** key is pressed.

**Note**

Default: *Reduce*

Edit ¹/₂

❖ Front Margin: Left/Right

You can specify left and right margins on the front side of copies in Margin Adjust mode.

Note

Default:

- Metric version: *Left 5mm*
- Inch version: *Left 0.2"*

❖ Back Margin: Left/Right

You can specify left and right margins on the back side of copies in Margin Adjust mode.

Note

Default:

- Metric version: *Right 5mm*
- Inch version: *Right 0.2"*

❖ Front Margin: Top/Bottom

You can specify front top and bottom margins on the front side of copies in Margin Adjust mode.

Note

Default:

- Metric version: *Bottom 0mm*
- Inch version: *Bottom 0.0"*

❖ Back Margin: Top/Bottom

You can specify back top and bottom margins on the front side of copies in Margin Adjust mode.

Note

Default:

- Metric version: *Bottom 0mm*
- Inch version: *Bottom 0.0"*

❖ 1 sided→2 sided Auto Margin:T to T

In 1 sided → 2 sided Duplex mode, you can specify whether to automatically set the margins on the back side.

The margin is set to the same value of "Back Margin: Left/Right".

Note

Default:

- Metric version: *Right 5mm*
- Inch version: *Right 0.2"*

❖ 1 sided→2 sided Auto Margin:T to B

In 1 sided → 2 sided Duplex mode, you can specify whether to automatically set the margins on the back side. The value set for "Back Margin: Top/Bottom" is used.

❖ Erase Border Width

The default setting of the width of the erased margins in Erase Border mode can be changed as follows:

- Metric version: 3 – 50mm in 1mm steps
- Inch version: 0.1" – 2.0" in 0.1" steps

Note

Default:

- Metric version: *10mm*
- Inch version: *0.4"*

❖ Erase Original Shadow in Combine

In Combine Copy or Booklet/Magazine Copy mode, you can specify whether to erase a 3mm, 0.1" bounding margin around all four edges of each original.

Note

Default: *Yes*

❖ Erase Center Width

The default setting of the width of the erased margins in Erase Centre mode can be changed as follows:

- Metric version: 2 – 99mm in 1mm steps
- Inch version: 0.1" – 3.9" in 0.1" steps

Note

Default:

- Metric version: *10mm*
- Inch version: *0.4"*

Edit ²/₂

◆ Image Repeat Separation Line

You can select a separation line in Image Repeat mode from None, Solid, Broken A, Broken B, or Crop Marks.

- None



- Solid



- Broken A



- Broken B



- Crop Marks



Note

- Default: *None*

◆ Double Copies Separation Line

You can select a separation line in Double Copy mode from None, Solid, Broken A, Broken B, or Crop Marks.

- None



- Solid



- Broken A



- Broken B



- Crop Marks



Note

- Default: *None*

◆ Separation Line in Combine

You can select a separation line in Combine mode from None, Solid, Broken A, Broken B, or Crop Marks.

- None



- Solid



- Broken A



- Broken B



- Crop Marks



Note

- Default: *None*

❖ Front Cover Copy in Combine

You can specify whether to make a combined copy on the front cover sheet when you select Front Cover copy mode.

Note

Default: *Combine*

❖ Designated Slip Sheet Copy in Combine

You can specify whether to make a combined copy on the inserted slip sheets in Desig./Chapter Copy mode.

Note

Default: *Combine*

❖ Copy on Designated Paper

You can specify whether to copy on the designate.

Note

Default: *Yes*

❖ Orientation: Booklet, Magazine

You can select the type of originals for Booklet or Magazine mode.

Note

Default: *Open to Left*

❖ Copy Order in Combine

You can set the copy order in Combine mode to “Left to Right” or “Top to Bottom”.

From Left to Right	From Top to Bottom																
<table border="1"> <tr> <td>1</td> <td>2</td> </tr> <tr> <td>3</td> <td>4</td> </tr> </table>	1	2	3	4	<table border="1"> <tr> <td>1</td> <td>3</td> </tr> <tr> <td>2</td> <td>4</td> </tr> </table>	1	3	2	4								
1	2																
3	4																
1	3																
2	4																
<table border="1"> <tr> <td>1</td> <td>2</td> <td>3</td> <td>4</td> </tr> <tr> <td>5</td> <td>6</td> <td>7</td> <td>8</td> </tr> </table>	1	2	3	4	5	6	7	8	<table border="1"> <tr> <td>1</td> <td>3</td> <td>5</td> <td>7</td> </tr> <tr> <td>2</td> <td>4</td> <td>6</td> <td>8</td> </tr> </table>	1	3	5	7	2	4	6	8
1	2	3	4														
5	6	7	8														
1	3	5	7														
2	4	6	8														

GCAH090E

Note

Default: *From left to right*

Stamp

Background Numbering

❖ Size

You can set the size of the numbers.

Note

Default: *Normal*

- Small
- Normal
- Large

❖ Density

You can set the density of the numbers.

Note

Default: *Normal*

Preset Stamp $1/4$ - $4/4$

❖ Stamp Priority

You can select the stamp type priority detected in Stamp mode.

Note

Default: *Copy*

❖ Stamp Language

You can select the language of the message that is printed in Stamp mode.

Note

Default: *English*

❖ Stamp Position

You can set the position at which the stamp is printed.
Press the arrow keys to adjust the position.

Note

Default:

- Metric Version:
 - Position: *Top right*
 - Top Margin: *24mm*
 - Right Margin: *24mm*

- Inch Version:
 - Position: *Top right*
 - Top Margin: *1.0"*
 - Right Margin: *1.0"*

❖ Stamp Format

You can adjust the size, density and print page for the stamp.

- Size
You can set the size of the stamp.

Note

- Default: *1X*

- Density
You can set the pattern used to print the stamp.

Note

- Default: *Normal*

- Normal: The stamp is printed on the image. You cannot confirm which parts overlap the image.

- Lighter: The image can be seen through the stamp.

- Light: You can see the image even clearer than in the "Lighter" setting.

- Print Page
You can select whether the stamp is printed on the first page or all pages.

Note

- Default: *All Pages*

User Stamp $1/2$ - $2/2$

❖ Program/Delete Stamp

You can register up to 4 custom stamps with your favorite design. You can register/change/delete your favorite design as a user stamp.

How to Program/Delete Stamp, ⇒ P.125 "Program/Delete User Stamp".

❖ Stamp Position

You can set the position at which the stamp is printed.
Press the arrow keys to adjust the position.

Note

- Default:
 - Metric version:
 - Position: *Top right*
 - Top Margin: *24mm*
 - Right Margin: *24mm*

- Inch version:
 - Position: *Top right*
 - Top Margin: *1.0"*
 - Right Margin: *1.0"*

❖ Stamp Format

You can adjust the print page for User Stamp 1 to 4 you registered.

Note

- Default: All Pages

Date Stamp

❖ Format

You can select the date format for Date Stamp mode.

Note

- Default:
 - Metric version: *DD/MM/YYYY*
 - Inch version: *MM/DD/YYYY*

❖ Font

You can select the Date Stamp font.

Note

- Default: *Font 1*
- This setting is linked with Page Numbering.

❖ Stamp Position

You can set the position at which the stamp is printed. Press the arrow keys to adjust the position.

Note

- Default:
 - Metric version:
 - Position: *Top left*
 - Top Margin: *8mm*
 - Left Margin: *32mm*
 - Inch version:
 - Position: *Top left*
 - Top Margin: *0.3"*
 - Left Margin: *0.8"*

❖ Stamp Setting

You can select whether the date is printed on the first page or all pages.

 Note

Default: All Pages

❖ Size

You can set the Date Stamp size.

 Note

Default: *Auto*

This setting is linked with Page Numbering.

❖ Superimpose

You can select whether the Date Stamp is printed negative when it overlaps black parts of the image.

 Note

Default: *No*

This setting is linked with Page Numbering.

Page Numbering $1/2-2/2$

❖ Stamp Format

You can select the page number format priority detected in Page Numbering mode.

 Note

Default: *P1, P2*

❖ Font

You can select the font of the page number that is printed in Page Numbering mode.

 Note

Default: *Font 1*

This setting is linked with Date Stamp.

❖ Size

You can set the size of the stamp that is printed in Page Numbering mode.

 Note

Default: *Auto*

This setting is linked with Date Stamp.

❖ Duplex Back Page Stamping Position

You can set the position of the duplex back page number that is printed in Duplex mode.

Note

Default: *Opposite Position*

❖ Page Numbering in Combine

You can set how the pages are numbered when you use the Combine function and Page Numbering function together.

Note

Default: *Per original*

❖ Stamp on Designated Slip Sheet

You can select whether to print the page number onto slip sheets when you use the Designate function set to “Copy” and Page Numbering function together.

Note

Default: *No*

❖ Stamp Position: P1, P2...Stamp Position: 1/5, 2/5...Stamp Position: -1-, -2-...Stamp Position: P.1, P.2...Stamp Position: 1, 2...Stamp Position: 1-1, 1-2...

You can set the position at which the stamp is printed. Press the arrow keys to adjust the position.

Note

Default:

- Metric version:
 - Position: P1, 1/5, P.1, 1: *Top right*, -1-, 1-1: *Bottom center*
 - Top/Bottom Margin: P1, 1/5, P.1, 1: *12mm*, -1-, 1-1: *8mm*
 - Left/Right Margin: P1, 1/5, P.1, 1: *12mm*, -1-, 1-1: *0mm*
- Inch version:
 - Position: P1, 1/5, P.1, 1: *Top right*, -1-, 1-1: *Bottom center*
 - Top/Bottom Margin: P1, 1/5, P.1, 1: *0.5"*, -1-, 1-1: *0.3"*
 - Left/Right Margin: P1, 1/5, P.1, 1: *0.5"*, -1-, 1-1: *0.0"*

❖ Superimpose

You can select whether page numbers are printed negative when they overlap black parts of the image.

Note

Default: *No*

This setting is linked with Date Stamp.

Input/Output

❖ Switch to Batch (SADF)

You can select Batch mode or SADF mode when you press the Special Original key.

❖ SADF Auto Reset

When you set one original at a time in the document feeder, the **Auto Feed** indicator lights for a selected time after an original is fed to show that the document feeder is ready for another original. You can adjust this time from 3 seconds to 99.

Note

Default: *5sec.*

❖ Rotate Sort: Auto Paper Continue

You can specify whether to continue copying when the paper of the required orientation has run out during rotate-sorting. ⇒ “Rotate Sort” in ⇒ P.43 “Sort”.

- If you select **[No]**:

When paper of the required orientation runs out, the machine stops copying and prompts you to supply copy paper. When you load paper, the machine will continue copying.

- If you select **[Yes]**:

Copying continues using copy paper of a different direction. The copy job will finish even if you have left the machine.

Note

Default: *No*

❖ Auto Sort

You can specify whether Sort mode is selected when the machine is turned on or the mode is cleared.

Note

Default: *No*

❖ Memory Full Auto Scan Restart

When the memory becomes full while scanning originals, the machine can make copies of the scanned originals first, then automatically proceed scanning the remaining originals.

You can enable or disable this function.

- If you select **[No]**:

When the memory becomes full, the machine stops operation allowing you to remove the copy pages delivered on the output tray.

- If you select **[Yes]**:

You can leave the machine unattended to make all the copies, but the resulting sorted pages will not be sequential.

Note

Default: *No*

❖ Select Stack Function

Specify which Stack or Rotate Sort is shown on the initial display with priority.

 Note

- Default: *Stack*
- The optional finisher or booklet finisher is required to use this function.

❖ Select Stapling Position

Specify which Top 2 staples or Bottom is shown on the initial display with priority.

 Note

- Default: *Top 2 staples*
- The optional 2 Tray Finisher is required to use this function.

❖ Letterhead Setting

If you want to copy on the direction-fixed (top to bottom) or 2-sided paper, the machine rotates the image correctly. To use this function, select “Yes”.

 Note

- Default: *No*

5

Do's And Don'ts

CAUTION:

- *Unplug the power cord from the wall outlet before you move the equipment. While moving the equipment, you should take care that the power cord will not be damaged under the equipment.*

Important

- If you want to unplug the power cord or turn off the main power switch, make sure that the remaining memory space indicates 100% on the display for facsimile mode.
- While the machine is unplugged, you can neither send nor receive a fax.

Reference

For details, see the Facsimile Reference.

- When you use this machine for a long time in a confined space without good ventilation, you may notice an odd smell. To keep the workplace comfortable, we recommend that you keep it well ventilated.
 - Do not press areas on or around the fusing unit. These areas get hot.
 - After making copies continuously, the exposure glass may feel warm—this is not a malfunction.
 - You might feel warm around the ventilation hole. This is caused by exhaust air, and is not a malfunction.
- Do not turn off the operation switch while copying or printing. Make sure that all copying or printing has finished.
 - The machine might fail to produce good copy images if condensation forms inside the machine due to rapid temperature change.
 - Do not open the covers of machine while copying or printing. If you do, misfeeds might occur.
 - Do not move the machine while copying or printing.
 - If you operate the machine improperly or a failure occurs on the machine, your machine settings might be lost. Be sure to take a note of your machine settings.
 - Supplier shall not be liable for any loss or damages resulting from a failure on the machine, loss of machine settings, and use of the machine.

Where to Put Your Machine

Machine Environment

Your machine's location should be carefully chosen because environmental conditions greatly affect its performance.

Optimum environmental conditions

CAUTION:

- *Keep the equipment away from humidity and dust. Otherwise a fire or an electric shock might occur.*
- *Do not place the equipment on an unstable or tilted surface. If it topples over, it could cause injury.*

CAUTION:

- *If you use the equipment in a confined space, make sure there is a continuous air turnover.*
- Temperature: 10 – 32°C (50 – 89.6°F) (humidity to be 54% at 32°C, 89.6°F)
- Humidity: 15 – 80% (temperature to be 27°C, 80.6°F at 80%)
- A strong and level base.
- The machine must be level within 5mm, 0.2" both front to rear and left to right.
- To avoid possible buildup of ozone, be sure to locate this machine in a large well ventilated room that has an air turnover of more than 30 m³/hr/person.

Environments to avoid

- Locations exposed to direct sunlight or strong light (more than 1,500 lux).
- Locations directly exposed to cool air from an air conditioner or heated air from a heater. (Sudden temperature changes might cause condensation within the machine.)
- Locations close to such machines generating ammonia as diazo copy machine.
- Places where the machine might be subjected to frequent strong vibration.
- Dusty areas.
- Areas with corrosive gases.

Moving

CAUTION:

- *Unplug the power cord from the wall outlet before you move the equipment. While moving the equipment, you should take care that the power cord will not be damaged under the equipment.*

Important

- If you move the machine, you must be careful as follows:
 - Turn off the main power ⇒ P.16 "Turning Off the Main Power"
 - Unplug the power cord from the wall. When you pull out the plug from the socket, grip the plug to avoid damaging the cord and causing fire or electric shock.
 - Close the front cover, the bypass tray, or others.

Limitation

- Carefully move the machine, If not, the machine might be damaged or stored file might be deleted.
- Do not take off the holding stand.
- Avoid any strong shocking to the machine, the hard disk might be damaged, and stored files will be deleted. For precautionary reasons files should be copied to another local computer.

Power Connection

⚠ WARNING:

- **Only connect the machine to the power source described on the inside front cover of this manual. Connect the power cord directly into a wall outlet and do not use an extension cord.**
- **Do not damage, break or make any modifications to the power cord. Do not place heavy objects on it. Do not pull it hard nor bend it more than necessary. These actions could cause an electric shock or fire.**

⚠ CAUTION:

- **Unplug the power cord from the wall outlet before you move the equipment. While moving the equipment, you should take care that the power cord will not be damaged under the equipment.**

⚠ CAUTION:

- **When you disconnect the power plug from the wall outlet, always pull the plug (not the cable).**

- When the main switch is in the Stand-by positions, the optional anti-condensation heaters are on. In case of emergency, unplug the machine's power cord.
- When you unplug the power cord, the anti-condensation heaters turn off.
- Make sure that the plug is firmly inserted in the outlet.
- Voltage must not fluctuate more than 10%.
- The socket-outlet shall be installed near the equipment and shall be easily accessible.

Access to the Machine

Place the machine near the power source, providing clearance as shown.

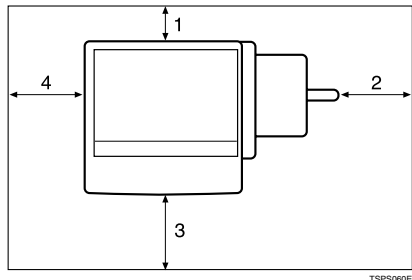

TSPS060E

1. Rear: more than 10 cm (4.0")
2. Right: more than 10 cm (4.0")
3. Front: more than 75 cm (29.6")
4. Left: more than 10 cm (4.0")

🔧 Note

- For the required space when options are installed, contact your service representative.

Maintaining Your Machine

If the exposure glass, platen cover, or document feeder belt is dirty, you might not be able to make copies as you want. Clean them if you find them dirty.

❖ Cleaning the machine

Wipe the machine with a soft, damp cloth. Then, wipe it with a dry cloth to remove the water.

⚠ Important

- ❑ Do not use chemical cleaner or organic solvent, such as thinner or benzene. If they get into the machine or melt plastic parts, a failure might occur.
- ❑ Do not clean parts other than those specified in this manual. Such parts should be cleaned by your service representative.

Cleaning the Exposure Glass



GDSH050J

Clean 1 and 2

Cleaning the Platen Cover

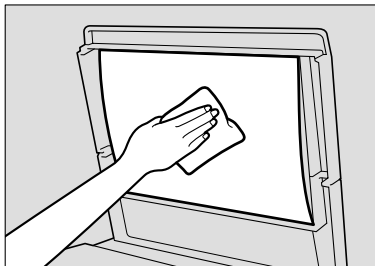

GDSH140J

Cleaning the Document Feeder

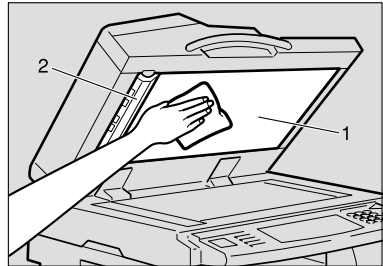

GDSH130J

Clean 1 and 2

Changing the Photoconductor Unit (PCU)

Only use the photoconductor unit made for this machine. Follow the procedure below to change unit.

⚠ Important

- ❑ Be sure to unplug the power cord from the outlet before changing the photoconductor unit.
- ① Open front door, duplex unit, and then transfer unit right cover.
 - ② Push the development unit to the left, and then pull the photoconductor unit out.
 - ③ Remove the harness clamps on the charge unit and cleaning unit of the new photoconductor unit.
 - ④ Push the development unit to the left, and then install the new photoconductor unit.

🔧 Note

- ❑ If the copy result is still not satisfactory after replacing the photoconductor unit, contact your service representative.

Mainframe

- ❖ **Configuration:**
Desktop
- ❖ **Photosensitivity type:**
OPC drum (Φ100)
- ❖ **Original scanning:**
One-dimensional solid scanning system through CCD
- ❖ **Copy process:**
Dry electrostatic transfer system
- ❖ **Development:**
Dry two-component magnetic brush development system
- ❖ **Fusing:**
Heating roll pressure system
- ❖ **Resolution:**
600 dpi
- ❖ **Exposure glass:**
Stationary original exposure type
- ❖ **Original reference position:**
Rear left corner
- ❖ **Warm-up time:**
From the main power switch
 - Type 1: Less than 15 seconds (20°C) (When Facsimile or Printer is installed:
Less than 18 seconds (20°C))
 - Type 2: Less than 20 seconds (20°C)From the operation switch
 - Type 1: Less than 10 seconds (20°C)
 - Type 2: Less than 15 seconds (20°C)
- ❖ **Originals:**
Sheet/book/objects
- ❖ **Maximum original size:**
A3☐, 11" × 17"☐

❖ Copy paper size:

- Trays: A3☐ – A5☐, 11" × 17"☐ – 5¹/₂" × 8¹/₂"☐
- Bypass: A3☐ – A6☐, 11" × 17"☐ – 5¹/₂" × 8¹/₂"☐
- Bypass (custom size):
Vertical: 100 – 297mm, 4.0" – 11.7"
Horizontal: 148 – 600mm, 5.9" – 23.6"
- Duplex: A3☐ – A5☐, 11" × 17"☐ – 5¹/₂" × 8¹/₂"☐ (impossible on A5☐, 5¹/₂" × 8¹/₂" ☐)
- LCT: A4☐, 8¹/₂" × 11"☐

❖ Copy paper weight:

- Paper tray: 64 – 105g/m², 17 – 28 lb.
- Bypass tray: 52 – 163g/m², 14 lb. – 43 lb.

❖ Non-reproduction area:

- Leading edge: Less than 3 ± 2mm
- Trailing edge: Less than 2 ± 2mm
- Left edge: Less than 2 ± 1.5mm
- Right edge: Less than 2 + 2.5/-1.5mm

❖ First copy time:

- Type 1: 4.5 seconds or less
(face up feed, A4☐, 100%, feeding from tray 1, on the exposure glass, Text·Photo mode, Auto Image Density)
- Type 2: 3.6 seconds or less
(face down feed, A4☐, 100%, feeding from tray 1, on the exposure glass, Text·Photo mode, Auto Image Density)

❖ Copying speed: (Type 1)

- 19 copies/minute (A3☐, 11" × 17"☐)
- 35 copies/minute (A4☐, 8¹/₂" × 11"☐)

❖ Copying speed: (Type 2)

- 22 copies/minute (A3☐, 11" × 17"☐)
- 45 copies/minute (A4☐, 8¹/₂" × 11"☐)

❖ Reproduction ratio:

Preset reproduction ratios:

	Metric version	Inch version
Enlargement	400%	400%
	200%	200%
	141%	155%
	122%	129%
	115%	121%
Full Size	100%	100%
Reduction	93%	93%
	82%	85%
	75%	78%
	71%	73%
	65%	65%
	50%	50%
	25%	25%

Zoom: From 25 to 400% in 1% steps.

❖ Maximum continuous copy run:

999 sheets

❖ Copy paper capacity:

- Tray 1, 2: 500 sheets (80g/m², 20 lb.)
- Bypass tray: 50 sheets (80g/m², 20 lb.)

❖ Power consumption:

- Mainframe only

	Type 1	Type 2
Warm-up	about 1.3 kw	about 1.3 kw
Stand-by	about 0.155 kw	about 0.175 kw
During printing	about 1.3 kw	about 1.3 kw
Maximum	less than 1.5 kw	less than 1.5 kw

- Complete system *1

	Type 1	Type 2
Warm-up	about 1.32 kw	about 1.32 kw
Stand-by	about 0.175 kw	about 0.195 kw
During printing	about 1.35 kw	about 1.35 kw
Maximum	less than 1.5 kw	less than 1.5 kw

*1 The Complete System consists of the mainframe, finisher and large capacity tray (LCT). 235

❖ **Dimensions (W × D × H up to exposure glass):**

Type 1, 2: 670 × 650 × 720mm, 26.4" × 25.6" × 28.3"

❖ **Space for mainframe (W × D):**

- Type 1, 2: 980 × 650mm, 38.6" × 25.6" (Bypass tray extender is used for large size paper)

❖ **Noise Emission *1:**

Sound Power Level:

- Mainframe only

	Type 1	Type 2
Stand-by	Less than 51 dB (A)	Less than 51 dB (A)
Copying	Less than 67 dB (A)	Less than 67 dB (A)

- Complete system *3

	Type 1	Type 2
Stand-by	Less than 52 dB (A)	Less than 52 dB (A)
Copying	Less than 70 dB (A)	Less than 70 dB (A)

Sound Pressure Level *2:

- Mainframe only

	Type 1	Type 2
Stand-by	Less than 37 dB (A)	Less than 37 dB (A)
Copying	Less than 54 dB (A)	Less than 54 dB (A)

- Complete system *3

	Type 1	Type 2
Stand-by	Less than 37 dB (A)	Less than 37 dB (A)
Copying	Less than 55 dB (A)	Less than 55 dB (A)

*1 The above measurements made in accordance with ISO 7779 are actual value.

*2 It is measured at the position of the bystander.

*3 The Complete System consists of the mainframe, finisher and large capacity tray (LCT).

❖ **Weight:**

Type 1, 2: Approx. 78 kg, 172 lb

❖ **HDD:**

10 GB or more







- Capacity for Document Server
4.2 GB
- Capacity for Memory sorting
1.5 GB
- Capacity for others
4.3 GB or more

Document Feeder (Option)

❖ Mode:

ADF mode, Batch mode, Mixed Size mode, Custom Size originals mode

❖ Original size:

- A3  – B6   (2 sided original are impossible for B6  )
- 11" × 17"  – 5¹/₂" × 8¹/₂"  

❖ Original weight:

- 1-sided originals: 40 – 128g/m² (11 – 34 lb.)
- 2-sided originals: 52 – 105g/m² (14 – 28 lb.) (Duplex)

❖ Number of originals to be set:

80 sheets (80g/m², 20 lb.) or less than 11mm, 0.43"

❖ Maximum power consumption:

Less than 60W (power is supplied from the main frame)

❖ Dimensions (W×D×H):

570 × 518 × 150mm, 22.4" × 20.3" × 5.9"

❖ Weight:

Approx. 12 kg, 26.5lb

Note

- Specifications are subject to change without notice.

1000-Sheet Finisher (Option)

❖ Paper size:

A3, B4, A4, B5, A5, B6, A6, 11" × 17", 8¹/₂" × 14", 8¹/₂" × 11", 5¹/₂" × 8¹/₂"

❖ Paper weight:

52 – 157g/m², 14 – 42 lb.

❖ Stack capacity:

- 1,000 sheets (A4, 8¹/₂" × 11" or smaller) (80g/m², 20 lb.)
- 500 sheets (B4, 8¹/₂" × 14" or larger) (80g/m², 20 lb.)

❖ Staple capacity:

- 30 sheets (A4, 8¹/₂" × 11" or smaller) (80g/m², 20 lb.)
- 20 sheets (B4, 8¹/₂" × 14" or larger) (80g/m², 20 lb.)

❖ Staple paper size:

A3, B4, A4, B5, 11" × 17", 8¹/₂" × 14", 8¹/₂" × 11"

❖ Staple paper weight:

64 – 80g/m², 17 – 20 lb.

❖ Staple position:

1 position (upper left)

❖ Power consumption:

48W (power is supplied from the main frame.)

❖ Dimensions (W × D × H):

568 × 520 × 625mm, 22.4" × 20.5" × 24.6"

❖ Weight:

Approx. 21kg, 46.3 lb

2 Tray Finisher (Option)

Finisher Shift Tray 1:

❖ Paper size:

A3☐, B4☐, A4☐☐, B5☐☐, A5☐☐, B6☐, A6☐, 11" × 17"☐, 8¹/₂" × 14"☐, 8¹/₂" × 11"☐☐, 5¹/₂" × 8¹/₂"☐☐

❖ Paper weight:

52 – 157g/m², 14 – 42 lb.

❖ Stack capacity:

- 500 sheets (A4☐☐, B5☐☐, A5☐, 8¹/₂" × 11"☐☐) (80g/m², 20 lb.)
- 250 sheets (A3☐, B4☐, 8¹/₂" × 14"☐, 11" × 17"☐s) (80g/m², 20 lb.)
- 100 sheets (A5☐, 5¹/₂" × 8¹/₂"☐☐) (80g/m², 20 lb.)

Finisher Shift Tray 2:

❖ Paper size:

A3☐, B4☐, A4☐☐, B5☐☐, A5☐☐, B6☐, A6☐, 11" × 17"☐, 8¹/₂" × 14"☐, 8¹/₂" × 11"☐☐, 5¹/₂" × 8¹/₂"☐☐

❖ Paper weight:

52 – 157g/m², 14 – 42 lb.

❖ Stack capacity:

No Staple:

- 2,000 sheets (A4☐, 8¹/₂" × 11"☐) (80g/m², 20 lb.)
- 750 sheets (A3☐, B4☐, A4☐, B5☐☐, 11" × 17"☐, 8¹/₂" × 14"☐, 8¹/₂" × 11"☐) (80g/m², 20 lb.)

Staple:

- 1,500 sheets (A4☐, 8¹/₂" × 11"☐) (80g/m², 20 lb.)
- 750 sheets (A3☐, B4☐, A4☐, B5☐☐, 11" × 17"☐, 8¹/₂" × 14"☐, 8¹/₂" × 11"☐) (80g/m², 20 lb.)
- 500 sheets (A5☐) (80g/m², 20 lb.)
- 100 sheets (A5☐, 5¹/₂" × 8¹/₂"☐☐) (80g/m², 20 lb.)

❖ Staple capacity:

- 50 sheets (A4☐☐, B5☐☐, 8¹/₂" × 11"☐☐) (80g/m², 20 lb.)
- 30 sheets (A3☐, B4☐, 11" × 17"☐, 8¹/₂" × 14"☐) (80g/m², 20 lb.)

❖ Staple paper size:

A3☐, B4☐, A4☐☐, B5☐☐, 11" × 17"☐, 8¹/₂" × 14"☐, 8¹/₂" × 11"☐☐

❖ Staple paper weight:

64 – 90g/m², 17 – 24 lb

❖ **Staple position:**

- 1 staple – 3 positions
- 2 staples – 1 position

❖ **Power consumption:**

Less than 60W (power is supplied from the main frame.)

❖ **Dimensions (W × D × H):**

























680 × 620 × 1.030mm, 26.7" × 24.4" × 40.5"

❖ **Weight:**

Approx. 55kg, 121.2 lb.

Punch Kit (Option)

❖ Paper size

- 2 holes: A3  – A5  , 11" × 17" , 8¹/₂" × 14"  – 5¹/₂" × 8¹/₂"  
- 3 holes: A3 , B4 , A4 , B5 , 11" × 17" , 8¹/₂" × 11" 
- 4 holes:
 - Metric version: A3 , B4 , A4 , B5 , 11" × 17" , 8¹/₂" × 11" 
 - Scandinavian version: A3  – A5 , 11" × 17" , 8¹/₂" × 14"  – 5¹/₂" × 8¹/₂" 

❖ Paper weight:

- 4 holes: 52 – 163g/m², 14 lb. – 43 lb.
- 2 or 3 holes: 52 – 163g/m², 14 lb. – 43 lb.

❖ Power consumption:

26.4 W (power is supplied from the mainframe.)

❖ Dimensions (W × D × H):

142 × 456 × 92mm, 55.9" × 179.5" × 36.2"

❖ Weight:

Approx. 2.9 kg, 6.4 lb

Note

- Specifications are subject to change without notice.

Internal tray 2 (1 bin tray) (Option)

❖ **Number of bins:**

1

❖ **Available paper size:**

A3☐, B4☐, B5☐☐, A5☐, 11" × 17"☐, 8¹/₂" × 14"☐, 8¹/₂" × 11"☐☐,
5¹/₂" × 8¹/₂" ☐

❖ **Paper capacity:**

125 sheets (80g/m², 20 lb.)

❖ **Copy paper weight:**

60 – 105g/m² (16 – 28lb.)

❖ **Maximum power consumption:**

Less than 15 W (power is supplied from the main frame.)

❖ **Dimensions (W × D × H):**

470 × 550 × 110mm, 18.6" × 21.7" × 4.4"

❖ **Weight:**

Approx. 4 kg, 8.9lb

 **Note**

☐ Specifications are subject to change without notice.

External Tray (Option)

❖ **Dimensions (W × D × H):**

265 × 395 × 65mm, 10.4" × 15.5" × 2.5"

❖ **Weight:**

Approx. 600 g, 1.3 lb

 **Note**

- Specifications are subject to change without notice.

Large Capacity Tray (LCT) (Option)

❖ **Paper size:**

A4 □, 8¹/₂" × 11" □

❖ **Paper weight:**

60 – 105g/m², 16 – 24 lb.

❖ **Paper capacity:**

1,500 sheets (80g/m², 20 lb.)

❖ **Power consumption**

Maximum. 40 W (power is supplied from the mainframe.)

❖ **Dimensions (W × D × H, option unit):**

390 × 500 × 390mm, 15.3" × 19.6" × 15.3"

❖ **Weight:**

Approx. 17 kg, 37.5 lb.

 **Note**

□ Specifications are subject to change without notice.

Paper tray unit (Option)

❖ Copy paper weight:

60 – 105g/m² (16 – 28 lb.)

❖ Available paper size:

A3, B4, A4, B5, A5, 11" × 17", 8¹/₂" × 14",
8¹/₂" × 11", 5¹/₂" × 8¹/₂", 8¹/₄" × 14", 11" × 14", 7¹/₄" × 10¹/₂",
8" × 13", 8" × 10¹/₂", 8¹/₂" × 13", 8" × 10¹/₂", 8¹/₄" × 13"

❖ Maximum power consumption:

Less than 50 W (power is supplied from the main frame.)

❖ Paper capacity:

550 sheets (80g/m², 20 lb.) × 2 trays

❖ Dimensions (W × D × H):

540 × 600 × 270mm, 21.3" × 23.7" × 10.7"

❖ Weight:

Approx. 25 kg, 55.2 lb.

Note

☐ Specifications are subject to change without notice.

INDEX

1000-Sheet Finisher, 8
1000-sheet finisher, 238
2 Tray Finisher, 8
2 Tray finisher, 239

A

Access to the Machine, 231
Adding Staples, 192
Adding Toner, 178
Auto Off, 28
Auto Reduce/Enlarge, 41

B

Back Cover, 135, 136
Background Numbering, 120
Basic functions, 35
Batch mode, 31
Book originals, copying, 98, 102
Border Erase, 113, 114
Bridge unit, 8
Bypass tray, 6, 58

C

Center/Border Erase, 116
Center Erase, 115
Centering, 111
Centre/Border Erase, 113
Centre Erase, 113
Changing Paper
 Tray 1 or 2, 188
Changing the Paper Size, 188
Chapter, 139
Check Modes key, 9
Clearing Misfeeds, 181
Clear Modes key, 9
Clear/Stop key, 10
Combination Chart, 143
Combine, 79, 85
Control Panel, 9
Control panel, 5
Copy Paper, 21, 38
Cover
 Back Cover, 135, 136
 Front Cover, 135, 136

D

Date Stamp, 127
Designate, 138
Directional Magnification (%), 75
Directional Size Magnification (mm), 77
Display, 11
Display panel, 9, 11
Document Feeder, 237
Document feeder, 5, 30
 Cleaning, 232
Document feeder (ADF), 8
Document Server, 145
 Deleting, 162
 Features and Benefits, 147
 Printing, 157
 Scanning Originals, 153
Do's And Don'ts, 229
Double Copies, 110

E

Energy Saver key, 9
Energy Saver mode, 66
Enhance, 69
Enlarging, 69
Environment, 230
Erase
 Border, 113, 114
 Center, 115
 Center/Border, 116
 Centre, 113
 Centre/Border, 113
Exposure glass, 5, 18, 29
 Cleaning, 232
External Tray, 243
Extender, 59
External tray, 8

F

File Merge Printing, 149
Finisher
 1000-Sheet Finisher, 8
Front Cover, 135, 136
Front cover, 5
Function Status indicator, 10

I

Image Density, 35, 36
Image Repeat, 109
Indicators, 9
Internal tray, 5
Internal tray 2 (1 bin tray), 8
Interrupt Copy, 66
Interrupt key, 9

J

Job Preset, 65

L

Large Capacity Tray (LCT), 8, 244
Loading Paper, 175
 Large Capacity Tray (LCT), 177
 Tray 1 or 2, 175
 Tray 3, 176
 Tray 4, 176

M

Machine Environment, 230
Mainframe, 233
Main power indicator, 5, 9
Main power switch, 5, 15
Maintenance, 232
Margin Adjustment, 118
Messages, 165
Misfeeds, 181
Mixed Size mode, 32

N

Numbering
 Background Numbering, 120
 Page Numbering, 130
Number keys, 10

O

On Demand Printing, 147
Operation switch, 9, 15
Options, 8
Original Beeper, 67
Originals, 18
Originals, setting, 29
Original Type selecting, 36
Output tray guide, 7

P

Page Numbering, 130
Paper
 Changing, 188
 Loading, 175
Paper tray, 5
Paper tray unit, 8
Platen cover, 8
Power Connection, 231
Preset Stamp, 121
Program
 Changing, 63
 Deleting, 63
 Recalling, 64
 Storing, 62
Program key, 9
Programs, 62
Punching copies, 54
Punch kit, 241

R

Reduce/Enlarge, 69
Reducing, 69
Remarks, 229
Removing Jammed Staples, 196
Removing Punch Waste, 200
Repeat
 Image Repeat, 109

S

- Safety information, i
- Sample Copy, 67
- Sample Copy key, 9
- Screen Contrast knob, 9
- Series Copies, 98
- Setting Custom Size Originals, 33
- Slip Sheets, 135, 141
- Sort, 42
- Sorting copies into sets, 43
- Specification, 233
 - Document Feeder*, 237
 - External Tray*, 243
 - Large Capacity Tray (LCT)*, 244
 - Mainframe*, 233
 - Punch kit*, 241
- Stack, 42, 45
- Stamp, 120
 - Background Numbering*, 120
 - Date Stamp*, 127
 - Page Numbering*, 130
 - Preset Stamp*, 121
 - User Stamp*, 123
- Staple, 42
- Staples, 192
 - Removing Jammed Staples*, 196
- Stapling copies, 47
- Start key, 9
- System Reset, 28

T

- Toner, 26
- Toner Bottle
 - Storage*, 26
- Two-sided Copies, 79, 82

U

- User Stamp, 123
- User Tools
 - Copy/Document Server Features*, 201
- User Tools/Counter key, 9

V

- Ventilation hole, 6

Z

- Zoom, 71

